

InDesign Publishing Engine 1.3 Reference Manual

Complete Reference to Sitecore Adaptive Print Studio

Chapter 1	Overview	5
Chapter 2	Introduction	6
	2.1 Structure Overview	7
Chapter 3	Project Elements	8
	3.1 Project Element	9
	3.2 Book Element	10
	3.3 Document Element	12
Chapter 4	Page Elements	14
	4.1 Pages Element	15
	4.2 Page Element	16
	4.3 TextFrame Element	17
	4.4 ImageFrame Element	20
	4.5 Image Element	23
	4.6 Ellipse Element	25
	4.7 Rectangle Element	28
	4.8 Line Element	31
	4.9 LinePoint Element	34
Chapter 5	Content Elements	35
	5.1 ParagraphStyle Element	36
	5.2 CharacterStyle Element	37
	5.3 SpecialCharacter Element	38
	5.4 InsertVar Element	39
	5.4.1 Using the InsertVar Element in a Table of Contents	39
	5.4.2 Using the InsertVar Element in an Index	45
Chapter 6	Tables	48
	6.1 Table Element	49
	6.2 Row Element	50
	6.3 Cell Element	51
Chapter 7	Inline Frames	53
	7.1 Inline Element	54
Chapter 8	Flow Elements	58
	8.1 Flows Element	59
	8.2 Flow Element	60
	8.3 Footnote Element	62
Chapter 9	Style Elements	65
	9.1 Preferences Element	66
	9.2 Colors Element	67
	9.3 Swatch Element	68
	9.4 Layer Element	69
	9.5 Styles Element	70
	9.6 Style Element	71
Chapter 10	Special Elements	77
	10.1 Variable Element	78

Chapter 1

Overview

This document describes the XML structure used by the Publishing Engine of Adaptive Print Studio. The document contains the following chapters:

- **Chapter 1 - Overview**
- **Chapter 2 - Introduction**
This chapter introduces some basic principles when publishing InDesign documents using the Sitecore Publishing Engine.
- **Chapter 3 - Project Elements**
This chapter describes the elements that build the basic project and document structure.
- **Chapter 4 - Page Elements**
This chapter describes the elements used to define pages and page objects.
- **Chapter 5 - Content Elements**
This chapter describes the content elements that can be used within a text frame, table cell or Inline frame.
- **Chapter 6 - Tables**
This chapter describes the elements involved with creating InDesign tables
- **Chapter 7 - Inline Frames**
This chapter describes the elements involved with creating Inline frames.
- **Chapter 8 - Flow Elements**
This chapter describes how to work with a flow type production and the footnote element.
- **Chapter 9 - Style Elements**
This chapter describes how to work with style elements.
- **Chapter 10 - Special Elements**
This chapter describes how to work with variables.

Chapter 2

Introduction

This chapter introduces some basic principles when publishing InDesign documents using the Sitecore Publishing Engine.

2.1 Structure Overview

The following schema shows the overall structure.

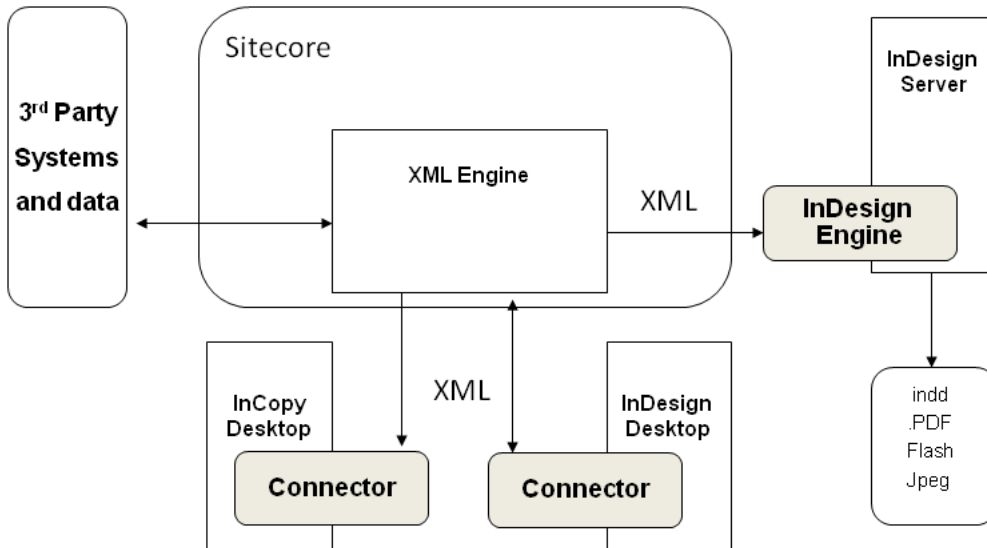

Chapter 3

Project Elements

This chapter describes the elements that build the basic project and document structure.

This chapter contains the following sections:

- Project Element
- Book Element
- Document Element

3.1 Project Element

The Project element has the following child element:

- Books element

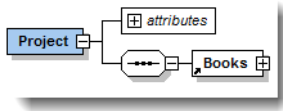

Project

Attribute	Default	Value (the default value in bold)	Description
Units	Implied	mm points	The units of measurement for the project (for font settings points are used always). Values points or mm, when no value is inserted or the attribute is not included the "points" value will be used.
CloseProject	Implied	True False	Redundant

3.2 Book Element

The Book element has the following child:

- Documents element

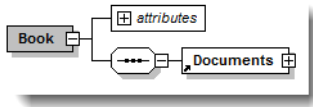

Book

Attribute	Default	Values (default value in bold)	Description
CreateBook	Implied	True False	True a book file is created. False no book file is created.
UseHighRes	Implied	True False	False LowResSrc full dos path (c:\.\name.gif) is used for publishing. True HighResSrc full dos path (c:\.\name.tiff) is used for publishing.
AutoUpdate	Implied	True False	Update the book file according to page order.
BlankPage	Implied	True False	Add blank InDesign page to document.
BookFilename	Implied		See note 1 at the end of this table.
ConvertVars	Implied	True False	False index variables are not converted to text. True the variable will be converted.
ExportPDF	Implied	True False	Export the book file to PDF or not. True a PDF file of the book is created.
ExportSWF	Implied	True False	Export to SWF format when set to True.
name	Implied		Name of item.
PageOrder	Implied	Odd Even Previous	The page order start number: Previous means start from previous document in book. Odd means start on odd page. Even means start on even page.
PDFExportSetting	Implied		Value is the desired PDF export setting for books or documents.
PDFFilename	Implied		The full dos path (c:\.\name.pdf) of the InDesign book.
PrintBook	Implied	True False	Print the entire book.
PrintPreset	Implied		The printer settings to use when printing the book using "PrintBook".
Repaginate	Implied		Only used internally by InDesign Connector plug-in.
SitecoreID	Implied		The unique ID of the item.
SWFFilename	Implied		The filename to use for the SWF file.
PageCurl	Implied	True False	If True page curl is enabled.
CurveQuality	Implied	0 .. 100 80	Sets the curve quality for the export.
SpineGradient	Implied	True False	If True, 'page spine' gradient is shown even when no page curl is in progress.
ShowCornerTease	Implied	True False	True a teaser animation is shown if user mouses over a corner.
EdgePercentage	Implied	0 .. 100 50	Integer. Real value indicating percentage of width/height for grabber area size.
MediaHandling	Implied	IncludeAll AppearanceOnly	Sets the preferred method for handling dynamic media page items.

Book (Continued)

Attribute	Default	Values (default value in bold)	Description
FrameRate	Implied	0 .. 100	Integer Set the frame rate for the generated SWF.
GenerateHTML	Implied	True False	Set to True, a HTML file is generated as well.
TranspBack	Implied	True False	Has transparent background (when transparent background, page curl is not possible) when set to True.
IncludePreloader	Implied	True False	Include preloader when set to True.
JpegQuality	Implied	Minimum Low Medium High Maximum	Set the JPEG quality.
Compression	Implied	Automatic Lossless JPEG	Set the compression.
Resolution	Implied	0 .. ∞ 72	Integer. Values in dpi Sets the preferred raster resolution for the export.
Spreads	Implied	True False	Sets whether to export as reader's spreads.
Threshold	Implied	72	Integer. Values in dpi Sets the raster resolution threshold.
ResamplingType	Implied	None Average Subsample Bicubic	Sets the algorithm to be used for resampling raster images that exceed the specified resolution threshold.
Sizing	Implied	Scale Size FitTo	Set the scale and fit settings to be applied for the export. Scale set scaling percentage Size set the exact width and height FitTo fit to screen resolution
FitToValue	Implied	1280 x 800 984 x 588 800 x 600 760 x 420 640 x 480 600 x 300	Set the value when Sizing is set to FitTo. Values in ppi.
Height	Implied	0 .. 100	Real numbers. Set the height when Sizing is set to Size.
Width	Implied	0 .. 100	Real numbers. Set the width when Sizing is set to Size.
TextExport	Implied	Vectorize Live Rasterize Vellum	Sets the text export policy for all text frame dictating how text is to be represented in the exported file.
Transparency	Implied	Ignore Flatten Native	Sets the preferred method for handling transparency on a page or spread, if it exists.
UseNetwork	Implied	True False	Set whether to allow using network access in generated SWF.
ViewAfterExport	Implied	True False	Sets whether to view the generated SWF file after exporting.
UpdateBook	Implied	True False	If set to true or left empty, will effect to book update.

3.3 Document Element

The Document element has the following child elements:

- Preferences Element
- Colors Element
- Layer Element
- Styles Element
- Variable Element
- Pages Element
- Flows Element

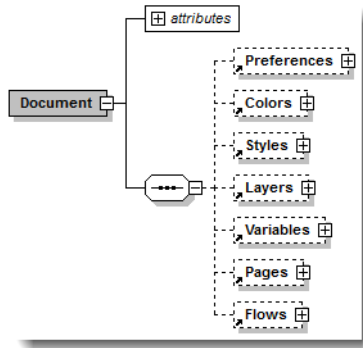

Document

Attribute	Default	Values (default value in bold)	Description/examples
Name	Implied		The document filename (indd) is compiled based on the following logic: If the DocFilename attribute has a value, that value is used for the filename. If a value is left empty: The indd filename = value of "OutputFolder" + value of "name" + value of "SitecoreID" + ".indb" Outputfolder is derived from XML source file location. If "name" is empty, the name is set to some default.
name	Implied		Name of the item.
SitecoreID	Implied		The unique ID of the item. If "SitecoreID" is empty a unique ID is generated.
Type	Implied	Static Dynamic	The document type. Dynamic means document created from XML, Static means static InDesign document. When using Static, the engine will use the document referred in the MasterFilename attribute and will save this document using the filename stated in the DocFilename attribute.
PageWidth	Implied		The width of the pages specified in the amount of specified units of measurement.
PageHeight	Implied		The height of the pages specified in the amount of specified units of measurement.
Bleed	Implied		The amount of bleed.
MasterFilename	Required		The full dos path (c:\.\name.indd) of the master document to use for this document. If left empty a new document is created using no master file.
DocFilename	Required		The full dos path (c:\.\name.indd) of the document to create/or use for this document. If left empty the filename is compiled using the name and SitecoreID attribute values. If those are left out or empty, the name is compiled using a unique identifier.

Document *(Continued)*

Attribute	Default	Values (default value in bold)	Description/examples
InsertFile	Implied		Not supported using the Adaptive Print Studio.
SaveAs	Implied		Not supported using the Adaptive Print Studio.
PageCount	Implied		The page count is driven by inserted value (No value means as is in XML, Odd means document always ends on odd page, Even means document always ends on even page.
ScriptFilename	Implied		Full path of an InDesign script added to document. For additional information we refer to the Adobe website/SDKs.
WaterMark	Implied	False	If set to True, a watermark is printed across all pages in the document.
MarkText	Implied	Default watermark	The watermark text.
MarkFontSize	Implied	58	The watermark text font size.
MarkFontColor	Implied	#555555	The font color in RGB (#rrggbb). For example #rrggbb (ff0000), which is red.
Shuffle	Implied	True False	If field is left empty, the master document settings are used.

Chapter 4

Page Elements

This chapter describes the elements used to define pages and page objects.

This chapter contains the following sections:

- Pages Element
- Page Element
- TextFrame Element
- ImageFrame Element
- Image Element
- Ellipse Element
- Rectangle Element
- Line Element
- LinePoint Element

4.1 Pages Element

The Pages element has the following child elements:

- Page Element - the page element has the following child elements:
 - TextFrame Element
 - ImageFrame Element
 - Ellipse Element
 - Rectangle Element
 - Path
- Flow Element - the Flow element has the child ParagraphStyle Element

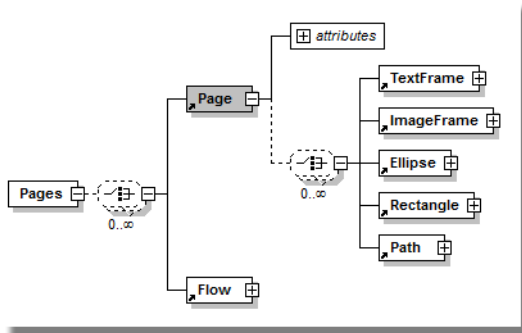

4.2 Page Element

Page

Attribute	Default	Values (default value in bold)	Description
name	Implied		Only used for internal purposes by InDesign Connector.
SitecoreID	Required		The SitecoreID attribute is used to identify each page object (Textframe, ImageFrame, etc) with a corresponding Sitecore item. The SitecoreID attribute contains the ID value of that specific item. Each page object item created with the InDesign Connector is related to a Sitecore item. Note: When using a script to create a page object (Textframe, ImageFrame, etc), you should add the SitecoreID attribute and use a default value (e.g. "null") so the InDesign Connector can identify this item.
Number	Required		The number used to identify the page. If a page exists, the page objects are added to that specific page. If it does not exist, a new page is created and the page objects are added to that new page.
MasterPrefix	Required		For InDesign for example "A", "B" and so on.
MasterBase	Required		For InDesign for example "Master".
Transition	Implied	Blinds Box Comb Cover Dissolve Fade PageTurn Push Split Uncover Wipe ZoomIn ZoomOut	Sets the page transition.
Direction	Implied	Down Left LeftDown LeftUp Right RightDown RightUp Up In Out Horizontal Vertical HorizontalIn HorizontalOut VerticalIn VerticalOut	Sets the transition direction.
Speed	Implied	Slow Medium Fast	Sets the transition speed.
ContNr	Implied	True False	If the attribute is not specified, the value is taken from the master document.

4.3 TextFrame Element

The TextFrame element holds the child ParagraphStyle Element.

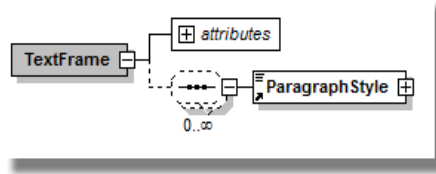

TextFrame

Attribute	Default	Values (default value in bold)	Description
Width	Required		The width of the graphic frame in the specified units.
Height	Required		The height of the graphic frame in the specified units.
X	Required		The horizontal position of the center point of the graphic frame with reference to the left corner point of the page in the specified units.
Y	Required		The vertical position center point of the graphic frame with reference to the left corner point of the page in the specified units.
Stroke	Implied		The stroke color in swatch or "#rrggbb" or cmyk "c=0;m=100;y=100;k=0;". Value of "None" mean no stroke. If a swatch is used and the swatch does not exist in the master document, it will be created using default color values.
StrokeThickness	Implied		The thickness of the stroke in points.
StrokeType	Implied	Solid ThickThick ThickThin ThickThinThick ThinThick ThinThickThin ThinThin Triple_Stroke Canned Dashed 3x2 Canned Dashed 4x4 Left Slant Hash Right Slant Hash Straight Hash Canned Dotted Wavy White Diamond Japanese Dots Dashed	Stroke values
Z-Index	Required		The z-index of the graphic frame. Can be used to move a frame to the front/back. If the z-index is unknown, use any value like for example 0.
Background	Implied		Background color in swatch or "#rrggbb" or cmyk "c=0;m=100;y=100;k=0;". Value of "None" mean no stroke. If a swatch is used and the swatch does not exist in the master document, it will be created using default color values.
LayerName	Required		The name of the layer where the graphic frame is put on. If the layer does not exist, it is created using defaults.
Rotation	Implied		The rotation of the graphic frame rotated round the centre middle. In degrees.
VerticalAlignment	Implied	Top Middle Bottom Justify	The vertical alignment of the content in the text frame.
Opacity	Implied		The opacity in percentage (values from 0 to 100) of the frame. When value is "0" no fill color is shown (means 0%) When the attribute is not used the standard InDesign value is used.
Transparency	Implied		The transparency of the graphic frame (as in InDesign). When value is "0" no fill color is shown (means 0%) When the attribute is not used the standard InDesign value is used.

TextFrame

Attribute	Default	Values (default value in bold)	Description
Name	Implied		Only used internally by the InDesign Connector.
CornerRadius	Implied		The corner effects setting in the specified units of the graphic frame.
CornerType	Implied	None Rounded Inverse Rounded Inset Bevel Fancy	The corner effect setting of the graphic frame. Ex: None None None None
margin-left	Implied		Left margin in the specified units.
margin-top	Implied		Top margin in the specified units.
margin-right	Implied		Right margin in the specified units.
margin-bottom	Implied		Bottom margin in the specified units.
Id	Implied		Only used internally.
Identifier	Implied		Only used internally.
FlowName	Implied		Name of the flow used for threaded text frames.
FlowOrder	Implied		The order of the text frame in the entire flow.
SitecoreID	Required		The SitecoreID attribute is used to identify each page object (Textframe, ImageFrame, etc) with a corresponding Sitecore item. The SitecoreID attribute contains the ID value of that specific item. Each page object item created with the InDesign Connector is related to a Sitecore item. Note: When using a script to create a page object (Textframe, ImageFrame, etc), you should add the SitecoreID attribute and use a default value (e.g. "null") so the InDesign Connector can identify this item.
SitecoreFieldname	Implied		Only used internally.
HorizontalScale	Implied		Value - / +. Value of 0.8 means scale to 80%. Value of 2 means 200%. HorizontalScale and VerticalScale always need to be set both in order to use scaling.
VerticalScale	Implied		Value - / +. Value of 0.8 means scale to 80%. Value of 2 means 200%. HorizontalScale and VerticalScale always need to be set both in order to use scaling.
Skew	Implied	0-360	Value in degrees.
NrOfColumns	Implied		Value number of columns used for text frames.
ColumnGutter	Implied		Value of gutter between columns.
ObjectStyle	Implied		An InDesign Object Style can be used for formatting (effects). If the name of the Object Style used in the master is used as value of this attribute it will be applied. If the objectstyle does not exist, it is NOT created automatically.
ScriptOverflow	Implied		The full file(s) path. Script is executed when text overflow is encountered for the text frame. 3 parameters are sent to the script. par1 documentname par2 XML ID par3 InDesign GUID
RunOnce	Implied	True False	True the scriptoverflow is only run once. False the script is executed until no overflow is encountered.
RunScript	Implied		The full file(s) path. Three parameters are sent to the script. par1 documentname par2 XML ID par3 InDesign GUID
FitFrame	Implied	True False	True the frame is auto fitted according to the text in the frame.

TextFrame

Attribute	Default	Values (default value in bold)	Description
ShowOverflow	Implied	True False	Show overflow indicator. Overflow frame uses "OverFlow" objectstyle and content uses "OverFlow" paragraphstyle. The calling frame gets a strokecolor called "OverFlow" Only works in InDesign server.
FillTint	Implied		The percentage of the tint for the background color.
StrokeTint	Implied		The percentage of the tint for the stroke color.
WMode	Implied	0 1 2 3 4 5 6 7 8	Wrap mode 0 no text wrap 1 jump object 2 jump to next column 3 wrap around bounding box 4 Invalid, unimplemented 5 Invalid, unimplemented 6 wrap around object shape 7 Invalid, unimplemented 8 Invalid, unimplemented
WOffset	Implied	top;left;bottom;right;single	Wrap offset Distance 1;2;1;2;0 Whether the item only supports one value for all sides (that is topMargin is the only valid margin) values 1/0
WInvert	Implied	0/1	Invert text wrap.
WSide	Implied	0 1 2 3 4 5	Wrap side 0 Both left & right sides 1 Left side 2 Right side 3 Side Towards Spine 4 Side Away from Spine 5 Largest Area
WIgnore	Implied	1 0	Ignore textwrap (only for textframes) 1 Ignore textwrap
LCap	Implied	0 1 2	Line cap 0 But cap 1 Round cap 2 Projecting cap
JType	Implied	0 1 2	Join type 0 Miter join 1 Round join 2 Bevel join
MLim	Implied		Miter limit
SAlign	Implied	0 1 2	Stroke alignment 0 Align stroke to center 1 Align stroke to inside 2 Align stroke to outside
LEnd	Implied	Simple Bar SquareSolid Square CircleSolid Circle Curved Barbed TriangleWide Triangle SimpleWide	(Line end) and LStart (line start)
BalCols	Implied	True/False	Balance columns

4.4 ImageFrame Element

The ImageFrame element has the child element Image.

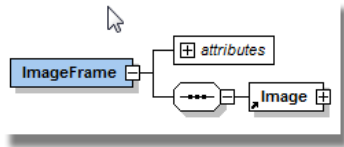

ImageFrame

Attribute	Default	Values (default value in bold)	Description
Width	Required		The width of the graphic frame in the specified units.
Height	Required		The height of the graphic frame in the specified units.
X	Required		The horizontal position of the center point of the graphic frame with reference to the left corner point of the page in the specified units.
Y	Required		The vertical position center point of the graphic frame with reference to the left corner point of the page in the specified units.
Stroke	Implied		The stroke color in swatch or "#rrggbb" or CMYK: "c=0;m=100;y=100;k=0;". Value of "None" means no stroke. If a swatch is used and the swatch does not exist in the master document, it will be created using default color values.
StrokeThickness	Implied		The thickness of the stroke in points.
StrokeType	Implied	Solid ThickThick ThickThin ThickThinThick ThinThick ThinThickThin ThinThin Triple_Stroke Canned Dashed 3x2 Canned Dashed 4x4 Left Slant Hash Right Slant Hash Straight Hash Canned Dotted Wavy White Diamond Japanese Dots Dashed	Stroke values.
Z-Index	Required		The z-index of the graphic frame. Can be used to move a frame to the front/back. If the z-index is unknown, use any value like for example 0.
Background	Implied		Background color in swatch or "#rrggbb" or cmyk "c=0;m=100;y=100;k=0;". Value of "None" mean no stroke. If a swatch is used and the swatch does not exist in the master document, it will be created using default color values.
LayerName	Required		The name of the layer where the graphic frame is put on. If the layer does not exist, it is created using defaults.
Rotation	Implied		The rotation of the graphic frame rotated round the centre middle. In degrees.
VerticalAlignment	Implied	Top Middle Bottom Justify	The vertical alignment of the content in the text frame.
Opacity	Implied		The opacity in percentage (values from 0 to 100) of the graphic frame.
Transparency	Implied		The transparency of the graphic frame (as in InDesign).
Name	Implied		Frame label (not used for now).
CornerRadius	Implied		The corner effects setting in the specified units of the graphic frame.

ImageFrame (Continued)

Attribute	Default	Values (default value in bold)	Description
CornerType	Implied	None Rounded Inverse Rounded Inset Bevel Fancy	The corner effect setting of the graphic frame. Ex: None None None None
Margin-left	Implied		Left margin in the specified units.
Margin-top	Implied		Top margin in the specified units.
Margin-right	Implied		Right margin in the specified units.
Margin-bottom	Implied		Bottom margin in the specified units.
Id	Implied		Only used internally.
Identifier	Implied		Only used internally.
SitecoreID	Required		The SitecoreID attribute is used to identify each page object (Textframe, ImageFrame, etc) with a corresponding Sitecore item. The SitecoreID attribute contains the ID value of that specific item. Each page object item created with the InDesign Connector is related to a Sitecore item. Note: When using a script to create a page object (Textframe, ImageFrame, etc), you should add the SitecoreID attribute and use a default value (e.g. "null") so the InDesign Connector can identify this item.
SitecoreFieldname	Implied		Only used internally.
Scaling	Implied	None AsIs Fit Content to Frame Fit Frame to Content Center Content Fit Content Proportionally Fill Frame Proportionally Fill Frame Proportionally and Center Fit Content Proportionally and Center	Images can be scaled automatically by using the values of this attribute. None use image width, height, x and y to position the image. AsIs place the image in its actual with and height.
HorizontalScale	Implied		Value - / +. Value of 0.8 means scale to 80%. Value of 2 means 200%. HorizontalScale and VerticalScale always need to be set both in order to use scaling.
VerticalScale	Implied		Value - / +. Value of 0.8 means scale to 80%. Value of 2 means 200%. HorizontalScale and VerticalScale always need to be set both in order to use scaling.
Skew	Implied		Value in degrees.
Center	Implied	True False	False do nothing True the image is placed as InDesign value "Center Content", attribute is used with scaling attributes.
FitFrame	Implied	True False	False do nothing True the frame is placed as InDesign value "Fit frame to Content", attribute is used with scaling attributes (values).
ObjectStyle	Implied		An InDesign Object Style can be used for formatting (effects). When the name of the Object Style used in the master is used as value of this attribute it will be applied. If the objectstyle does not exist, it is NOT created automatically.
RunScript	Implied		The full file(s) path. 3 Parameters are sent to the script. par1 documentname par2 XML iD par3 InDesign GUID
FillTint	Implied		The percentage of the tint for the background color.
StrokeTint	Implied		The percentage of the tint for the stroke color.

ImageFrame (Continued)

Attribute	Default	Values (default value in bold)	Description
WMode	Implied	0 1 2 3 4 5 6 7 8	Wrap mode. 0 no text wrap 1 jump object 2 jump to next column 3 wrap around bounding box 4 Invalid, unimplemented 5 Invalid, unimplemented 6 wrap around object shape 7 Invalid, unimplemented 8 Invalid, unimplemented
WOffset	Implied	top;left;bottom;right;single	Distance of wrap offset Ex: 1;2;1;2;0; Whether the item only supports one value for all sides (that is topMargin is the only valid margin) values 1/0
WInvert	Implied	0/1	Invert text wrap
WSide	Implied	0 1 2 3 4 5	Wrap side 0 both left & right sides 1 Left side 2 Right side 3 Side Towards Spine 4 Side Away from Spine 5 Largest Area
LCap	Implied	0 1 2	Line cap 0 But cap 1 Round cap 2 Projecting cap
JType	Implied	0 1 2	Join type 0 Miter join 1 Round join 2 Bevel join
MLim	Implied		Miter limit
SAlign	Implied	0 1 2	Stroke alignment) 0 Align stroke to center 1 Align stroke to inside 2 Align stroke to outside
LEnd	Implied	Simple Bar SquareSolid Square CircleSolid Circle Curved Barbed TriangleWide Triangle SimpleWide	(Line end) and LStart (line start).

4.5 Image Element

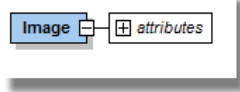

Image

Attribute	Default	Values (default value in bold)	Description/examples
Width	Required		The width of the graphic frame in the specified units.
Height	Required		The height of the graphic frame in the specified units.
X	Required		The horizontal position of the center point of the graphic frame with reference to the center point of the ImageFrame in the specified units.
Y	Required		The vertical position center point of the graphic frame with reference to the center point of the ImageFrame in the specified units.
LowResSrc	Required		The full dos path (c:\.\name.gif) of low resolution images.
HighResSrc	Required		The full dos path (c:\.\name.tiff) of high resolution images.
Name	Implied		Only used internally.
Rotation	Implied		The rotation of the graphic frame rotated round the centre middle. In degrees.
Id	Implied		Only used internally.
Identifier	Implied		Only used internally.
SitecoreID	Required		The SitecoreID attribute is used to identify each page object (Textframe, ImageFrame, etc) with a corresponding Sitecore item. The SitecoreID attribute contains the ID value of that specific item. Each page object item created with the InDesign Connector is related to a Sitecore item. Note: When using a script to create a page object (Textframe, ImageFrame, etc), you should add the SitecoreID attribute and use a default value (e.g. "null") so the InDesign Connector can identify this item.
SitecoreFieldname	Implied		Only used internally.
HorizontalScale	Implied		Value - / +. Value of 0.8 means scale to 80%. Value of 2 means 200%. HorizontalScale and VerticalScale always need to be set both in order to use scaling.
VerticalScale	Implied		Value - / +. Value of 0.8 means scale to 80%. Value of 2 means 200%. HorizontalScale and VerticalScale always need to be set both in order to use scaling.
Skew	Implied		Value in degrees.
ObjectStyle	Implied		An InDesign Object Style can be used for formatting (effects). When the name of the Object Style used in the master is used as value of this attribute it will be applied. If the objectstyle does not exist, it is NOT created automatically.
RunScript	Implied		The full file(s) path. Three parameters are sent to the script. par1 document name par2 XML ID par3 InDesign GUID
Wmode	Implied	0 1 2 3 4 5 6 7 8	Wrap mode. 0 No text wrap 1 Jump object 2 Jump to next column 3 Wrap around bounding box 4 Invalid, unimplemented 5 Invalid, unimplemented 6 Wrap around object shape 7 Invalid, unimplemented 8 Invalid, unimplemented

Image (Continued)

Attribute	Default	Values (default value in bold)	Description/examples
WOffset	Implied	top;left;bottom;right;single	Distance of wrap offset Ex: 1;2;1;2;0; Whether the item only supports one value for all sides (that is topMargin is the only valid margin) values 1/0.
WInvert	Implied	0/1	Invert text wrap.
WSide	Implied	0 1 2 3 4 5	Wrap side 0 Both left & right sides 1 Left side 2 Right side 3 Side Towards Spine 4 Side Away from Spine 5 Largest Area
WCont	Implied	0 1 2 3 4 5	Wrap contour 0 Graphic Bounds 1 Detect Edges 2 Using Alpha Channel 3 Using Photoshop Path 4 Graphic Frame 5 SameAsClip

4.6 Ellipse Element

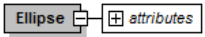

Ellipse

Attribute	Default	Values (default value in bold)	Description
Width	Required		The width of the graphic frame in the specified units.
Height	Required		The height of the graphic frame in the specified units.
X	Required		The horizontal position of the center point of the graphic frame with reference to the left corner point of the page in the specified units.
Y	Required		The vertical position center point of the graphic frame with reference to the left corner point of the page in the specified units.
Stroke	Implied		The stroke color in swatch or "#rrggbb" or CMYK "c=0;m=100;y=100;k=0;". Value of "None" means no stroke. If a swatch is used and the swatch does not exist in the master document, it will be created using default color values.
StrokeThickness	Implied		The thickness of the stroke in points.
StrokeType	Implied	Solid ThickThick ThickThin ThickThinThick ThinThick ThinThickThin ThinThin Triple_Stroke Canned Dashed 3x2 Canned Dashed 4x4 Left Slant Hash Right Slant Hash Straight Hash Canned Dotted Wavy White Diamond Japanese Dots Dashed	Stroke values.
Z-Index	Required		The z-index of the graphic frame. Can be used to move a frame to the front/back. If the z-index is unknown, use any value like for example 0.
Background	Implied		Background color in swatch or "#rrggbb" or cmyk "c=0;m=100;y=100;k=0;". Value of "None" mean no stroke. If a swatch is used and the swatch does not exist in the master document, it will be created using default color values.
LayerName	Required		The name of the layer where the graphic frame is put on. If the layer does not exist, it is created using defaults.
Rotation	Implied		The rotation of the graphic frame rotated round the centre middle. In degrees.
Opacity	Implied		The opacity in percentage (values from 0 to 100) of the graphic frame.
Transparency	Implied		The transparency of the graphic frame (as in InDesign).
Name	Implied		Only used internally.
CornerRadius	Implied		The corner effects setting in the specified units of the graphic frame.
CornerType	Implied	None Rounded Inverse Rounded Inset Bevel Fancy	The corner effect setting of the graphic frame (as in InDesign). Ex: None None None None
Id	Implied		Only used internally.
Identifier	Implied		Only used internally.

Ellipse (Continued)

Attribute	Default	Values (default value in bold)	Description
SitecoreID	Required		The SitecoreID attribute is used to identify each page object (Textframe, ImageFrame, etc) with a corresponding Sitecore item. The SitecoreID attribute contains the ID value of that specific item. Each page object item created with the InDesign Connector is related to a Sitecore item. Note: When using a script to create a page object (Textframe, ImageFrame, etc), you should add the SitecoreID attribute and use a default value (e.g. "null") so the InDesign Connector can identify this item.
SitecoreFieldname	Implied		Only used internally.
HorizontalScale	Implied		Value - / +. Value of 0.8 means scale to 80%. Value of 2 means 200%. HorizontalScale and VerticalScale always need to be set both in order to use scaling.
VerticalScale	Implied		Value - / +. Value of 0.8 means scale to 80%. Value of 2 means 200%. HorizontalScale and VerticalScale always need to be set both in order to use scaling.
Skew	Implied		Value in degrees.
ObjectStyle	Implied		An InDesign Object Style can be used for formatting (effects). When the name of the Object Style used in the master is used as value of this attribute it will be applied. If the objectstyle does not exist, it is NOT created automatically.
RunScript	Implied		The full file(s) path. Three parameters are sent to the script. par1 documentname par2 XML iD par3 InDesign GUID
FillTint	Implied		The percentage of the tint for the background color.
StrokeTint	Implied		The percentage of the tint for the stroke color.
WMode	Implied	0 1 2 3 4 5 6 7 8	Wrap mode 0 no text wrap 1 jump object 2 jump to next column 3 wrap around bounding box 4 Invalid, unimplemented 5 Invalid, unimplemented 6 wrap around object shape 7 Invalid, unimplemented 8 Invalid, unimplemented
WOffset	Implied	top;left;bottom;right;single	Distance of wrap offset Ex: 1;2;1;2;0 Whether the item only supports one value for all sides (that is topMargin is the only valid margin) values 1/0.
WInvert	Implied	0/1	Invert text wrap.
WSide	Implied	0 1 2 3 4 5	Wrap side 0 both left & right sides 1 Left side 2 Right side 3 Side Towards Spine 4 Side Away from Spine 5 Largest Area
LCap	Implied	0 1 2	Line cap 0 But cap 1 Round cap 2 Projecting cap
JType	Implied	0 1 2	Join type 0 Miter join 1 Round join 2 Bevel join
MLim	Implied		Miter limit

Ellipse (Continued)

Attribute	Default	Values (default value in bold)	Description
SAlign	Implied	0 1 2	Stroke alignment 0 Align stroke to center 1 Align stroke to inside 2 Align stroke to outside
LEnd LStart	Implied	Simple Bar SquareSolid Square CircleSolid Circle Curved Barbed TriangleWide Triangle SimpleWide	Line end Line start

4.7 Rectangle Element



Rectangle

Attribute	Default	Values (default value in bold)	Description
Width	Required		The width of the graphic frame in the specified units.
Height	Required		The height of the graphic frame in the specified units.
X	Required		The horizontal position of the center point of the graphic frame with reference to the left corner point of the page in the specified units.
Y	Required		The vertical position center point of the graphic frame with reference to the left corner point of the page in the specified units.
Stroke	Implied		The stroke color in swatch or "#rrggbb" or CMYK "c=0;m=100;y=100;k=0;". Value of "None" mean no stroke. If a swatch is used and the swatch does not exist in the master document, it will be created using default color values.
StrokeThickness	Implied		The thickness of the stroke in points.
StrokeType	Implied	Solid ThickThick ThickThin ThickThinThick ThinThick ThinThickThin ThinThin Triple_Stroke Canned Dashed 3x2 Canned Dashed 4x4 Left Slant Hash Right Slant Hash Straight Hash Canned Dotted Wavy White Diamond Japanese Dots Dashed	Stroke values.
Z-Index	Required		The z-index of the graphic frame. Can be used to move a frame to the front/back. If the z-index is unknown, use any value like for example 0.
Background	Implied		Background color in swatch or "#rrggbb" or CMYK "c=0;m=100;y=100;k=0;". Value of "None" mean no stroke. If a swatch is used and the swatch does not exist in the master document, it will be created using default color values.
LayerName	Required		The name of the layer where the graphic frame is put on. If the layer does not exist, it is created using defaults.
Rotation	Implied		The rotation of the graphic frame rotated round the centre middle. In degrees.
Opacity	Implied		The opacity in percentage (values from 0 to 100) of the graphic frame.
Transparency	Implied		The transparency of the graphic frame (as in InDesign).
Name	Implied		Only used internally.
CornerRadius	Implied		The corner effects setting in the specified units of the graphic frame.
CornerType	Implied	None Rounded Inverse Rounded Inset Bevel Fancy	The corner effect setting of the graphic frame (as in InDesign). Ex: None None None None
Id	Implied		Only used internally.
Identifier	Implied		Only used internally.

Rectangle (Continued)

Attribute	Default	Values (default value in bold)	Description
SitecoreID	Required		The SitecoreID attribute is used to identify each page object (Textframe, ImageFrame, etc) with a corresponding Sitecore item. The SitecoreID attribute contains the ID value of that specific item. Each page object item created with the InDesign Connector is related to a Sitecore item. Note: When using a script to create a page object (Textframe, ImageFrame, etc), you should add the SitecoreID attribute and use a default value (e.g. "null") so the InDesign Connector can identify this item.
SitecoreFieldname	Implied		Only used internally.
HorizontalScale	Implied		Value - / +. Value of 0.8 means scale to 80%. Value of 2 means 200%. HorizontalScale and VerticalScale always need to be set both in order to use scaling.
VerticalScale	Implied		Value - / +. Value of 0.8 means scale to 80%. Value of 2 means 200%. HorizontalScale and VerticalScale always need to be set both in order to use scaling.
Skew	Implied		Value in degrees.
ObjectStyle	Implied		An InDesign Object Style can be used for formatting (effects). When the name of the Object Style used in the master is used as value of this attribute it will be applied. If the objectstyle does not exist, it is NOT created automatically.
RunScript	Implied		The full file(s) path. Three parameters are sent to the script. par1 documentname par2 XML iD par3 InDesign GUID
FillTint	Implied		The percentage of the tint for the background color.
StrokeTint	Implied		The percentage of the tint for the stroke color.
WMode	Implied	0 1 2 3 4 5 6 7 8	Wrap mode 0 no text wrap 1 jump object 2 jump to next column 3 wrap around bounding box 4 Invalid, unimplemented 5 Invalid, unimplemented 6 wrap around object shape 7 Invalid, unimplemented 8 Invalid, unimplemented
WOffset	Implied	top;left;bottom;right;single	Distance of wrap offset Ex: 1;2;1;2;0; Whether the item only supports one value for all sides (that is topMargin is the only valid margin) values 1/0.
WInvert	Implied	0/1	Invert text wrap.
WSide	Implied	0 1 2 3 4 5	Wrap side 0 both left & right sides 1 Left side 2 Right side 3 Side Towards Spine 4 Side Away from Spine 5 Largest Area
LCap	Implied	0 1 2	Line cap 0 But cap 1 Round cap 2 Projecting cap
JType	Implied	0 1 2	Join type 0 Miter join 1 Round join 2 Bevel join
MLim	Implied		Miter limit

Rectangle *(Continued)*

Attribute	Default	Values (default value in bold)	Description
SAlign	Implied	0 1 2	Stroke alignment 0 Align stroke to center 1 Align stroke to inside 2 Align stroke to outside
LEnd	Implied	Simple Bar SquareSolid Square CircleSolid Circle Curved Barbed TriangleWide Triangle SimpleWide	(Line end) and LStart (line start)

4.8 Line Element

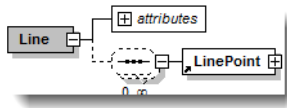

Line

Attribute	Default	Values (default value in bold)	Description
Width	Implied		The width of the graphic frame in the specified units. Be aware that initially the line is determined by the LinePoints. The width and height is only used to scale the object once created. When publishing a straight (horizontal) line, the width is not used.
Height	Implied		The width of the graphic frame in the specified units. Be aware that initially the line is determined by the LinePoints. The width and height is only used to scale the object once created. When publishing a straight (horizontal) line, the width is not used.
X	Implied		The horizontal position of the center point of the graphic frame with reference to the left corner point of the page in the specified units. Be aware that the line is initially determined by the LinePoints. The X and Y are only used to move the object once it is created.
Y	Implied		The vertical position center point of the graphic frame with reference to the left corner point of the page in the specified units. Be aware that the line is initially determined by the LinePoints. The X and Y are only used to move the object once it is created.
Background	Implied		Background color in swatch or "#rrggbb" or CMYK "c=0;m=100;y=100;k=0;". Value of "None" mean no stroke. If a swatch is used and the swatch does not exist in the master document, it will be created using default color values.
Closed	Implied	True False	True start and end point are joined. False no joining.
CornerRadius	Implied	N/A	Frame label (not used for now).
CornerType	Implied	None Rounded Inverse Rounded Inset Bevel Fancy	The corner effects setting in the specified units of the graphic frame. Ex: None None None None
FillTint	Implied		The percentage of the tint for the background color.
Id	Implied		Only used internally.
Identifier	Implied		Only used internally.
JType	Implied	0 1 2	Join type 0 Miter join 1 Round join 2 Bevel join
LayerName	Implied		The name of the layer where the graphic frame is put on. If the layer does not exist, it is created using defaults.
LCap	Implied	0 1 2	Line cap 0 But cap 1 Round cap 2 Projecting cap
LEnd LStart	Implied	Simple Bar SquareSolid Square CircleSolid Circle Curved Barbed TriangleWide Triangle SimpleWide	(Line end) and LStart (line start).
MLim	Implied		Miter limit.

Line (Continued)

Attribute	Default	Values (default value in bold)	Description
Name	Implied		Only used internally.
ObjectStyle	Implied		An InDesign Object Style can be used for formatting (effects). When the name of the Object Style used in the master is used as value of this attribute it will be applied. If the objectstyle does not exist, it is NOT created automatically.
Opacity	Implied		The vertical alignment of the content in the textframe.
Rotation	Implied		The rotation of the graphic frame rotated round the centre middle. In degrees.
RunScript	Implied		The full file(s) path. Three parameters are sent to the script. par1 documentname par2 XML iD par3 InDesign GUID
SAlign	Implied	0 1 2	Stroke alignment 0 Align stroke to center 1 Align stroke to inside 2 Align stroke to outside
SitecoreFieldname	Implied		Only used internally.
SitecoreID	Required		The SitecoreID attribute is used to identify each page object (Textframe, ImageFrame, etc) with a corresponding Sitecore item. The SitecoreID attribute contains the ID value of that specific item. Each page object item created with the InDesign Connector is related to a Sitecore item. Note: When using a script to create a page object (Textframe, ImageFrame, etc), you should add the SitecoreID attribute and use a default value (e.g. "null") so the InDesign Connector can identify this item.
Stroke	Implied		The stroke color in swatch or "#rrggbb" or CMYK "c=0;m=100;y=100;k=0;". Value of "None" mean no stroke. If a swatch is used and the swatch does not exist in the master document, it will be created using default color values.
StrokeThickness	Implied		The thickness of the stroke in points.
StrokeTint	Implied		The percentage of the tint for the stroke color.
StrokeType	Implied	Solid ThickThick ThickThin ThickThinThick ThinThick ThinThickThin ThinThin Triple_Stroke Canned Dashed 3x2 Canned Dashed 4x4 Left Slant Hash Right Slant Hash Straight Hash Canned Dotted Wavy White Diamond Japanese Dots Dashed	Stroke values.
Transparency	Implied	0-100	Real Numbers The opacity in percentage of the graphic frame.
WInvert	Implied	0 1	Invert text wrap
WMode	Implied	0 1 2 3 4 5 6 7 8	0 (no text wrap) 1 (jump object) 2 (jump to next column) 3 (wrap around bounding box) 4 Invalid, unimplemented 5 Invalid, unimplemented 6 (wrap around object shape) 7 Invalid, unimplemented 8 Invalid, unimplemented

Line (Continued)

Attribute	Default	Values (default value in bold)	Description
WOffset	Implied	top left bottom right single	Distance of wrap offset. Ex: 1 ;2;1;2;0;
WSide	Implied	0 1 2 3 4 5	Wrap side 0 Both left & right sides 1 Left side 2 Right side 3 Side Towards Spine 4 Side Away from Spine 5 Largest Area
Z-Index	Implied		The z-index of the graphic frame. Can be used to move a frame to the front/back. If the z-index is unknown, use any value like for example 0.

4.9 LinePoint Element



LinePoint

Attribute	Default	Values (default value in bold)	Description
AnchorPointX	Implied		The horizontal position of the anchor point in the specified units.
AnchorPointY	Implied		The vertical position of the anchor point in the specified units.
LeftDirPointX	Required		The horizontal position of the Left-direction point in the specified units.
LeftDirPointY	Required		The vertical position of the Left-direction point in the specified units.
PointType	Required	kL kCS kCK	kL Line point kCS Continuous smooth point kCK Continuous unsmooth point
RightDirPointX	Implied		The horizontal position of the Right-direction point in the specified units.
RightDirPointY	Implied		The vertical position of the Right-direction point in the specified units.

Chapter 5

Content Elements

This chapter describes the content elements that can be used within a text frame, table cell or Inline frame.

This chapter contains the following sections:

- ParagraphStyle Element
- CharacterStyle Element
- SpecialCharacter Element
- InsertVar Element

5.1 ParagraphStyle Element

The ParagraphStyle Element has the following child elements:

- CharacterStyle Element
- SpecialCharacter Element
- Inline Element
- InsertVar Element
- Table Element

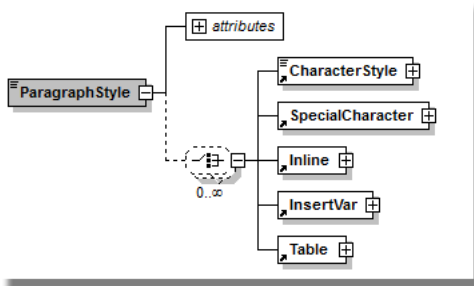

ParagraphStyle

Attribute	Default	Values (default value in bold)	Description/examples
Style	Required		The style name that needs to be used to format this paragraph.

5.2 CharacterStyle Element

The CharacterStyle element has the following child elements:

- SpecialCharacter Element
- Inline Element
- InsertVar Element
- Table Element

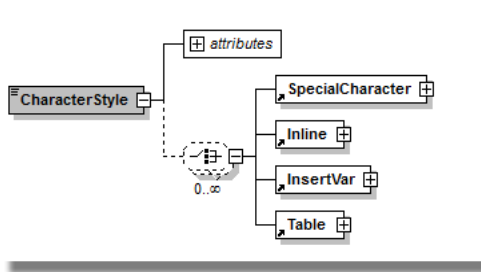

CharacterStyle

Attribute	Default	Value (default value in bold)	Description
Style	Required		The style name that needs to be used to format this set of characters.

5.3 SpecialCharacter Element

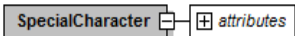

SpecialCharacter attributes

SpecialCharacter

Attribute	Default	Values	Description
Type	Required	3 7 8 9 10 24 25 160 173 8212 8211 8209 8193 8194 8195 8199 8200 8201 8202 1396927554	3 End nested style 7 Indent to here 8 Right aligned tab 9 Tab 10 Hard return (new paragraph) 24 Page numbers 25 Section marker 160 Nonbreaking space 173 Discretionary hyphen 8212 Em dash 8211 En dash 8209 Nonbreaking Hyphen 8193 Flush space 8194 En space 8195 Em space 8199 Figure space 8200 Punctuation space 8201 Thin space 8202 Hair space 1396927554 Column break

5.4 InsertVar Element

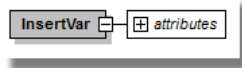

InsertVar

Attribute	Default	Value(s)	Description
Name			Name of the variable. If the variable does not exist in the master, a new variable of the type "Custom Text" is created. If the variable exists (regardless of type) it is inserted in the content at the place where the InsertVar element is placed.
Value			Value of the variable (content). The value will only be set if the variable is of the type "Custom Text".

5.4.1 Using the InsertVar Element in a Table of Contents

Besides using the InsertVar element to insert variables in the content, you can also use the InsertVar element to generate a table of contents and/or index. To generate a table of contents, you need to publish the InsertVar element in the content and publish a corresponding InsertVar element in the table of contents. The source element will be used to determine the page number. The page number will be published at the location of the target variable.

In the content:

```
<InsertVar Name="TTOC_1" Value="" />
```

In the table of contents:

```
<InsertVar Name="TOC_1" Value="" />
```

Make sure the name of the source variable uses the prefix "TTOC_" and the target variable uses the prefix "TOC_". You can add any other value, for example "TTOC_DOC_1".

An example of a basic XML:

```

1  <?xml version="1.0" encoding="UTF-8" standalone="yes"?>
2  <Project Units="points" CloseProject="True">
3    <Books>
4      <Book BookFilename="" ExportPDF="False" PrintBook="False">
5        <Documents>
6          <Document Type="Dynamic" MasterFilename="" DocFilename="c:\temp\tests\TOC_test.indd" PageWidth="612.0000000000000000" PageHei
7          <Preferences SuperScriptPos="33.299999999999997" SuperScriptSize="58.299999999999997" SubScriptPos="33.299999999999997" Sul
8          <Colors>
9          <Styles>
94        <Layers>
95        <Pages>
96          <Page MasterPrefix="A" MasterBase="Master" Number="1">
97            <TextFrame Width="100" Height="100" X="80" Y="80" Z-Index="11">
98              <ParagraphStyle Style="P_ProductGroup">table of contents</ParagraphStyle>
99              <ParagraphStyle Style="Body">Title 1<SpecialCharacter Type="9"/><InsertVar Name="TOC_1" Value=""/></ParagraphStyle>
100             <ParagraphStyle Style="Body">Title 2<SpecialCharacter Type="9"/><InsertVar Name="TOC_2" Value=""/></ParagraphStyle>
101            </TextFrame>
102          </Page>
103          <Page MasterPrefix="A" MasterBase="Master" Number="2">
104            <TextFrame Width="150" Height="150" X="150" Y="150" Z-Index="11">
105              <ParagraphStyle Style="P_ProductGroup">source contents
106              </ParagraphStyle>
107              <ParagraphStyle Style="Body">This is the source title 1<InsertVar Name="TTOC_1" Value=""/></ParagraphStyle>
108              <ParagraphStyle Style="Body">This is the source title 2<InsertVar Name="TTOC_2" Value=""/></ParagraphStyle>
109            </TextFrame>
110          </Page>
111        </Pages>
112      </Documents>
113    </Book>
114  </Books>
115 </Project>

```

This would generate a document with the first page:

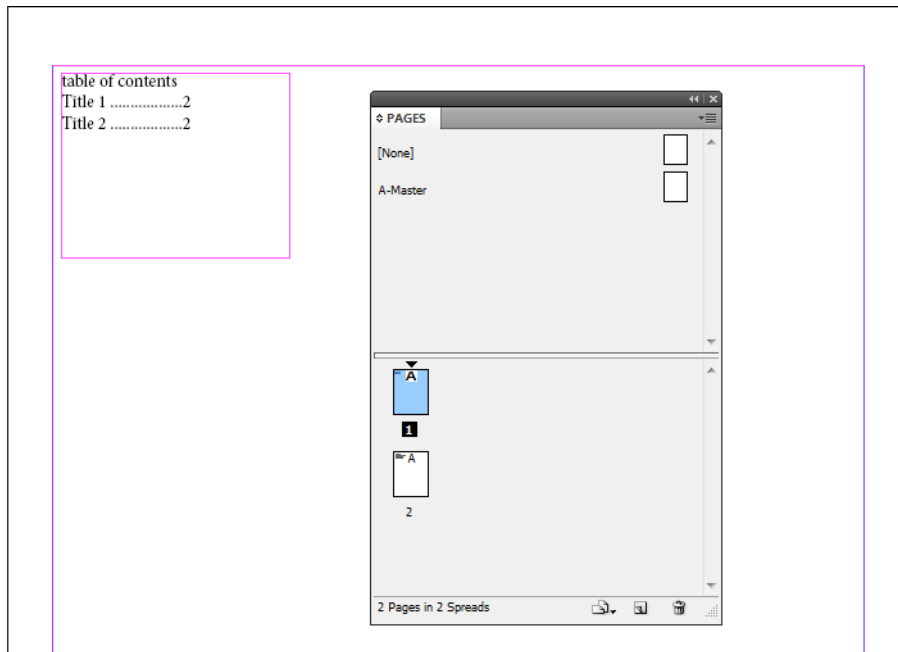

The second page (with the source content):

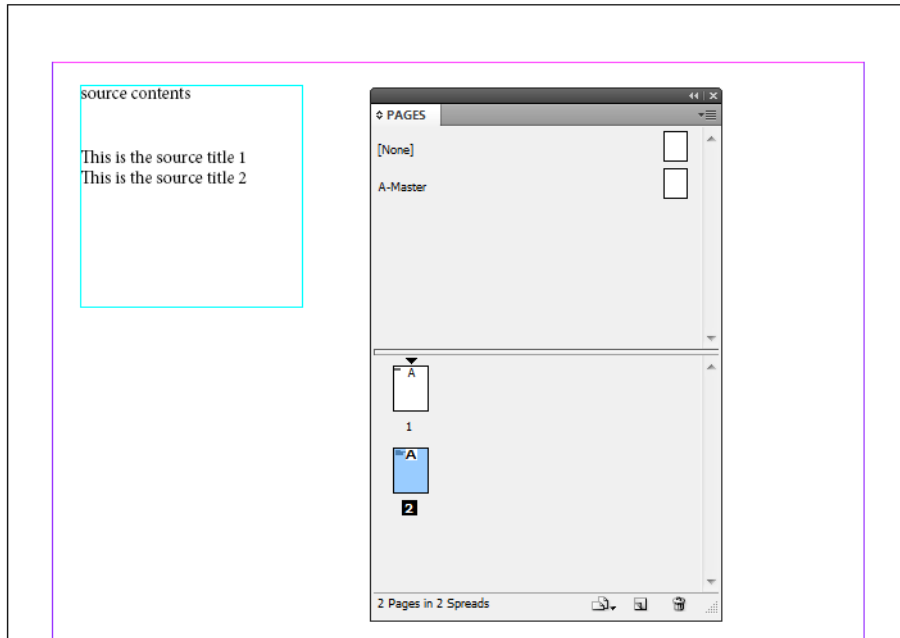

If you work with several documents in a book, you can use the same steps to publish a separate table of contents document inside the book.

A sample XML could look like:

```

4 <Book CreateBook="True" BookFilename="c:\temp\tests\TOCBook.indb" ExportPDF="False" PrintBook="False">
5 <Documents>
6 <Document Type="Dynamic" MasterFilename="c:\temp\tests\TOCmaster.indd" DocFilename="c:\temp\tests\TOC_test.indd" PageWidth="612
7 <Preferences SuperScriptPos="33.299999999999997" SuperScriptSize="58.299999999999997" SubScriptPos="33.299999999999997" Sub
8 <Colors>
94 <Styles>
125 <Layers>
133 <Pages>
134 <Page MasterPrefix="A" MasterBase="Master" Number="1">
135 <TextFrame Width="100" Height="100" X="80" Y="80" Z-Index="11">
136 <ParagraphStyle Style="P_ProductGroup">table of contents</ParagraphStyle>
137 <ParagraphStyle Style="Body">Title 1<SpecialCharacter Type="9"/><InsertVar Name="TOC_1" Value=""/></ParagraphStyle>
138 <ParagraphStyle Style="Body">Title 2<SpecialCharacter Type="9"/><InsertVar Name="TOC_2" Value=""/></ParagraphStyle>
139 <ParagraphStyle Style="Body">Title 2<SpecialCharacter Type="9"/><InsertVar Name="TOC_3" Value=""/></ParagraphStyle>
140 <ParagraphStyle Style="Body">Title 2<SpecialCharacter Type="9"/><InsertVar Name="TOC_4" Value=""/></ParagraphStyle>
141 </TextFrame>
142 </Page>
143 </Pages>
144 </Document>
145 <Document Type="Dynamic" MasterFilename="c:\temp\tests\TOCmaster.indd" DocFilename="c:\temp\tests\TOC_content_test.indd" PageWid
146 <Preferences SuperScriptPos="33.299999999999997" SuperScriptSize="58.299999999999997" SubScriptPos="33.299999999999997" Sub
147 <Colors>
233 <Styles>
264 <Layers>
272 <Pages>
273 <Page MasterPrefix="A" MasterBase="Master" Number="5">
274 <TextFrame Width="150" Height="150" X="150" Y="150" Z-Index="11">
275 <ParagraphStyle Style="P_ProductGroup">source contents
276 </ParagraphStyle>
277 <ParagraphStyle Style="Body">This is the source title 1<InsertVar Name="TTOC_1" Value=""/></ParagraphStyle>
278 <ParagraphStyle Style="Body">This is the source title 2<InsertVar Name="TTOC_2" Value=""/></ParagraphStyle>
279 </TextFrame>
280 </Page>
281 <Page MasterPrefix="A" MasterBase="Master" Number="">
282 <TextFrame Width="150" Height="150" X="150" Y="150" Z-Index="11">
283 <ParagraphStyle Style="P_ProductGroup">source contents
284 </ParagraphStyle>
285 <ParagraphStyle Style="Body">This is the source title 3<InsertVar Name="TTOC_3" Value=""/></ParagraphStyle>
286 <ParagraphStyle Style="Body">This is the source title 4<InsertVar Name="TTOC_4" Value=""/></ParagraphStyle>
287 </TextFrame>
288 </Page>
289 </Pages>
290 </Document>
291 </Documents>
292 </Book>

```

Note

Please note that the start number of the first page in the second document is set to 5 since we (for this example) want the first document to start on page number 5.

To set the numbering options:

1. Select the first page in the master document.

2. Right-click and select **Numbering & Section Options**:

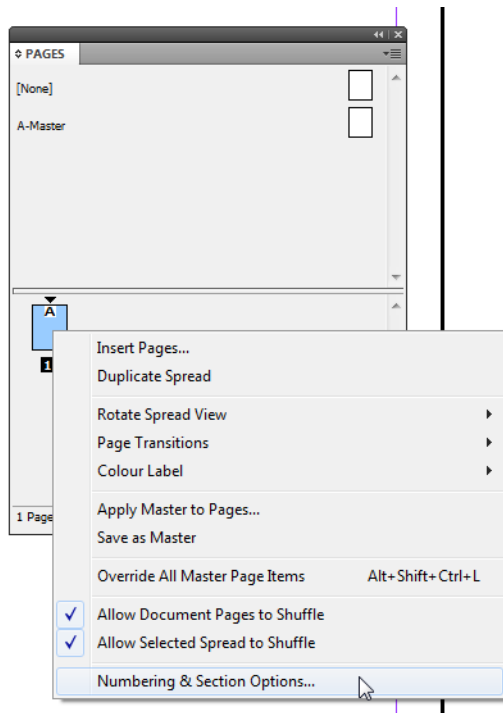

The “Numbering & Section Options” dialog is displayed:

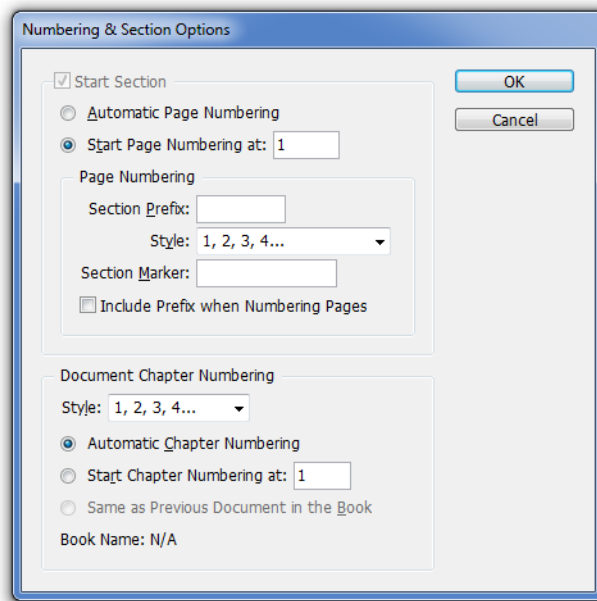

3. Set the value to 1 in the **Start Page Numbering at:** box. When the document is generated the start number will be set from the XML and in this case 1 will be set to 5.

This would produce a book file and two documents. This would look like:

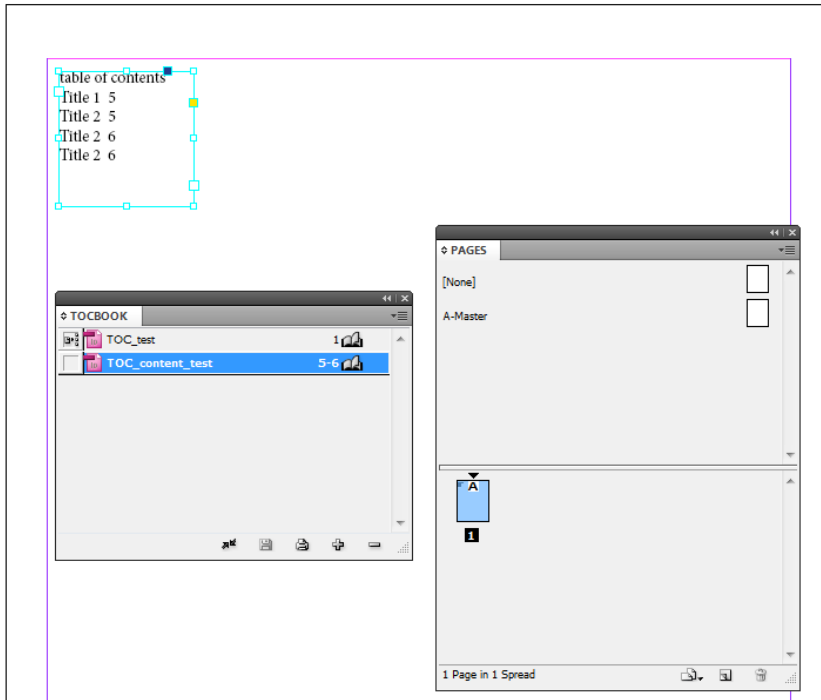

and:

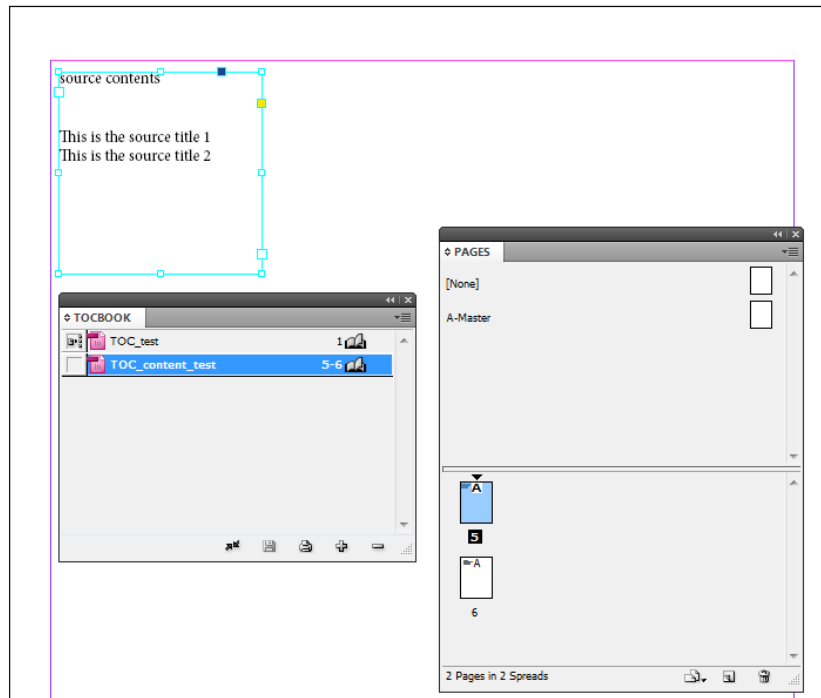

Note

Documents with facing Pages selected (left and right pages face each other in a double-page spread) that start with an even page number (Number attribute) begin on the left page. Odd-numbered pages are right-hand pages.

5.4.2 Using the InsertVar Element in an Index

To generate an index, you need to publish the InsertVar element in the content and you need to publish a corresponding InsertVar element in the index as well. Then, the source element will be used to determine the page number and the page number will be published at the location of the target variable.

In the content:

```
<InsertVar Name="TI_1" Value=""/>
```

In the index:

```
<InsertVar Name="I_1" Value=""/>
```

The index helps you to find information in long documents. Therefore you need several places in the content where variables correspond with an index variable.

A sample XML could look like:

```

1  <?xml version="1.0" encoding="UTF-8" standalone="yes"?>
2  <Project Units="mm">
3    <Books>
4      <Book CreateBook="True" BookFilename="c:\temp\tests\INXBook.indb" ExportPDF="False" PrintBook="False">
5        <Documents>
6          <Document Type="Dynamic" MasterFilename="c:\temp\tests\INXmaster.indd" DocFilename="c:\temp\tests\INX_content_test.indd" PageWidth=
7            <Pages>
8              <Page MasterPrefix="A" MasterBase="Master" Number="1">
9                <TextFrame Width="150" Height="150" X="150" Y="150" Z-Index="11">
10                 <ParagraphStyle Style="P_ProductGroup">source contents
11                 </ParagraphStyle>
12                 <ParagraphStyle Style="Body">This is the source item 1<InsertVar Name="TI_0" Value=""/>
13                 </ParagraphStyle>
14                 <ParagraphStyle Style="Body">This is the source item 2<InsertVar Name="TI_1" Value=""/>
15                 </ParagraphStyle>
16                 </TextFrame>
17               </Page>
18              <Page MasterPrefix="A" MasterBase="Master" Number="">
19                <TextFrame Width="150" Height="150" X="150" Y="150" Z-Index="11">
20                 <ParagraphStyle Style="P_ProductGroup">source contents
21                 </ParagraphStyle>
22                 <ParagraphStyle Style="Body">This is the source item 1<InsertVar Name="TI_0" Value=""/>
23                 </ParagraphStyle>
24                 <ParagraphStyle Style="Body">This is the source item 2<InsertVar Name="TI_2" Value=""/>
25                 </ParagraphStyle>
26                 </TextFrame>
27               </Page>
28            </Pages>
29          </Document>
30        <Document Type="Dynamic" MasterFilename="c:\temp\tests\INXmaster.indd" DocFilename="c:\temp\tests\INX_test.indd" PageWidth="612.0
31          <Pages>
32            <Page MasterPrefix="A" MasterBase="Master" Number="3">
33              <TextFrame Width="100" Height="100" X="80" Y="80" Z-Index="11">
34                <ParagraphStyle Style="P_ProductGroup">Index</ParagraphStyle>
35                <ParagraphStyle Style="Body">Item 1<SpecialCharacter Type="9"/>
36                  <InsertVar Name="I_0" Value=""/>
37                </ParagraphStyle>
38                <ParagraphStyle Style="Body">Item 2<SpecialCharacter Type="9"/>
39                  <InsertVar Name="I_1" Value=""/>
40                </ParagraphStyle>
41              </TextFrame>
42            </Page>
43          </Pages>
44        </Document>
45      </Documents>
46    </Book>
47  </Books>

```

In InDesign this would look like:

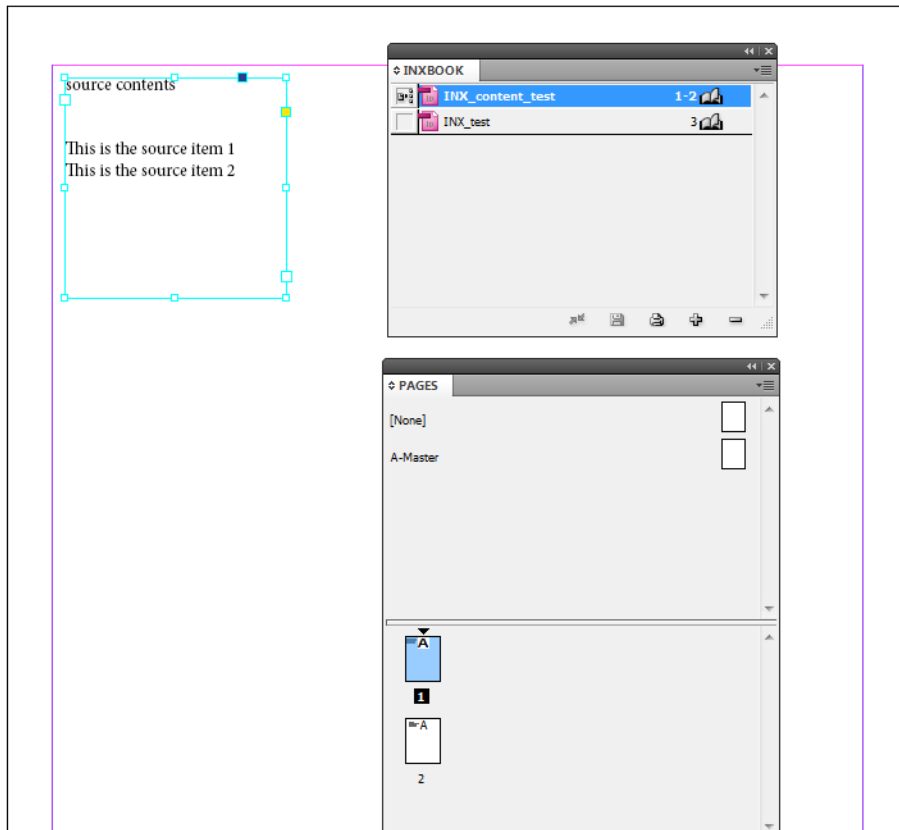

And in the index document:

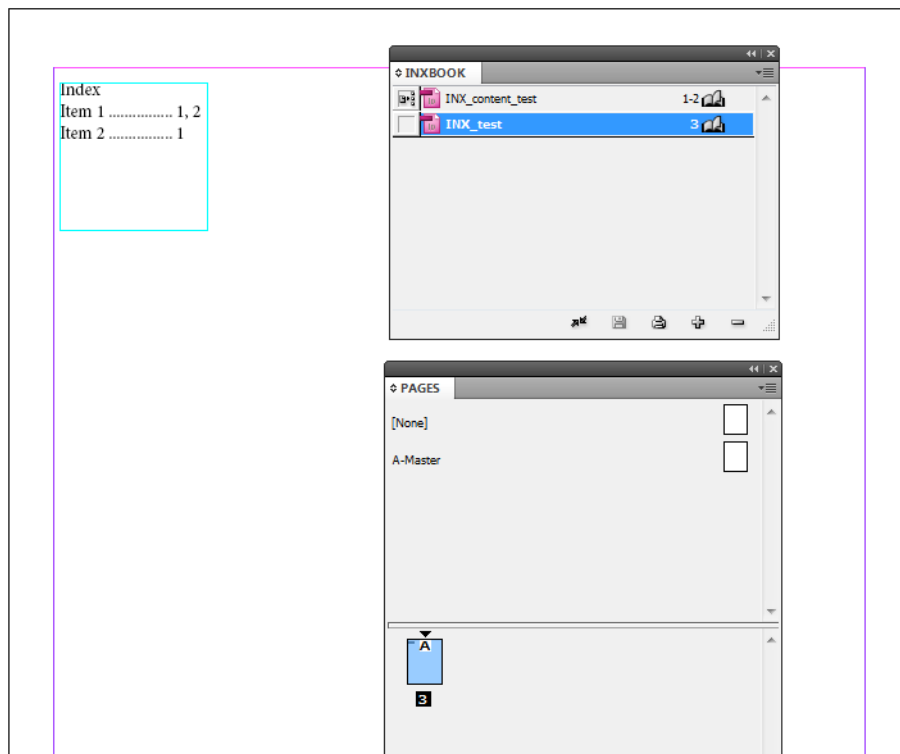

Chapter 6

Tables

This chapter describes the elements involved with creating InDesign tables.

This chapter contains the following sections:

- Table Element
- Row Element
- Cell Element

6.1 Table Element

The Table element has the following child element:

- Row Element

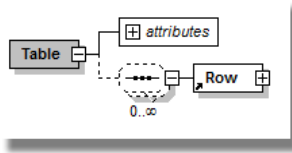

Table

Attribute	Default	Value (default value in bold)	Description
TableStyle	Implied		The name of the table style to use for this table. If the style is not available in the master, the table style is created using defaults.
ColCount	Implied		The number of columns. The default value is taken from the structure (number of cells in first row). If ColCount ≤ 0 -> then the table is not created. If ColCount value is less than the number of cells in the structure, then the number of cells out of structure taken over. Be aware: The number of columns always needs to be larger than 0 and can't be left empty. The number of columns also needs to correspond with the amount of cell elements for each row in the XML.
HeaderRows	Implied		The number of header rows. The RowCount includes the number of header rows. So for a table with 1 header row and 9 body rows the rowcount is 10.
FooterRows	Implied		The number of footer rows. The RowCount includes the number of header rows. For a table with 1 header row, 1 footer row and 8 body rows the rowcount is 9.
RowCount	Implied		The number of rows. If left empty, the number of rows is determined based on the XML structure of the table. The default value is taken from the structure (the number of rows of the table). If RowCount ≤ 0 -> then the table is not created. If RowCount value is less than the number of rows in the structure, the value taken over structure.
RepeatHeader	Implied	OncePerPage OncePerFrame EveryTextColumn	Sets the way the table header is repeated.
RepeatFooter	Implied	OncePerPage OncePerFrame EveryTextColumn	Sets the way the table footer is repeated.

6.2 Row Element

The Row element has the following child element:

- Cell Element

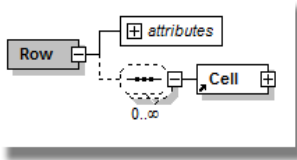

Row

Attribute	Default	Value (default value in bold)	Description
RowHeight	Implied	AtLeast Exactly)	How to set the row height.
RowMin	Implied	2	Minimum height of a row.
RowMax	Implied	200	Maximum height of a row.
StartRow	Implied	Anywhere NextColumn NextFrame NextPage NextOddPage NextEvenPage	Sets the way this row needs to be positioned.
KeepWithNext	Implied	True False	Set to True if the row needs to remain together with the row above.

6.3 Cell Element

The Cell element has the following child element:

- ParagraphStyle Element

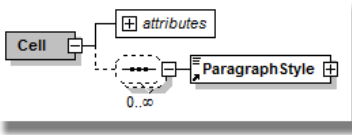

Cell

Attribute	Default	Value(s)	Description
CellStyle	Required		The name of the cell style. If the cell style does not exist in the master document, it is created using defaults.
ColWidth	Required		The width of the column.
HorStradle	Required		Value is horizontal stradle (stradle of columns: no stradle value is "0" when no value is inserted "0" is used default. Two columns stradle value is "1")
VerStradle	Required		Vertical stradle (stradle of rows: no stradle value is "0" when no value is inserted "0" is used by default. Two rows stradle value is "1")

The following example shows how to use the HorStradle attribute to merge the first three cells of the first row.

```

1  <?xml version="1.0" encoding="UTF-8"?>
2  <!DOCTYPE Table SYSTEM "D:\SourceCode\engine schema\PrintStud
3  <Table ColCount="" HeaderRows="" FooterRows="" TableStyle="">
4  <Row>
5  <Cell CellStyle="" ColWidth="" HorStradle="2" VerStradle=""/>
6  <Cell CellStyle="" ColWidth="" HorStradle="0" VerStradle=""/>
7  <Cell CellStyle="" ColWidth="" HorStradle="0" VerStradle=""/>
8  <Cell CellStyle="" ColWidth="" HorStradle="0" VerStradle=""/>
9  </Row>
10 <Row>
11 <Cell CellStyle="" ColWidth="" HorStradle="0" VerStradle=""/>
12 <Cell CellStyle="" ColWidth="" HorStradle="0" VerStradle=""/>
13 <Cell CellStyle="" ColWidth="" HorStradle="0" VerStradle=""/>
14 <Cell CellStyle="" ColWidth="" HorStradle="0" VerStradle=""/>
15 </Row>
16 </Table>
17

```

This will create the following table in InDesign:

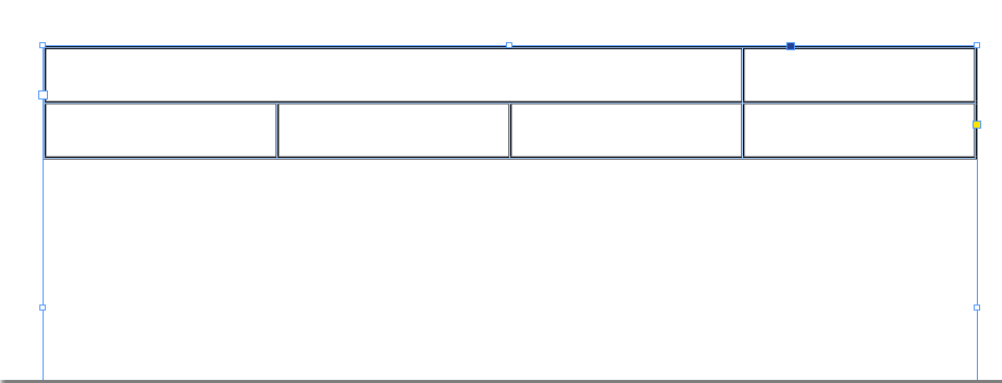

Chapter 7

Inline Frames

This chapter describes the elements involved with creating Inline frames.

This chapter contains the following sections:

- Inline Element

7.1 Inline Element

The Inline element has the following child elements:

- Image Element
- ParagraphStyle Element

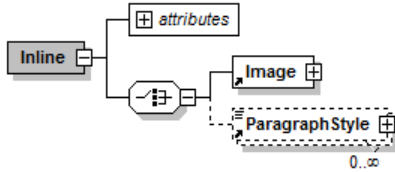

Inline

Attribute	Default	Value (default value in bold)	Description
Type	Required	Text Graphic Ellipse Rectangle Path	Text Text frame Graphic Graphic frame Ellipse Ellipse Rectangle Rectangle Path Path.
ParagraphStyle	Implied		Then type text is used the paragraph style to format the content can be set here.
Height	Required		The height of the graphic frame in the specified units.
Width	Required		The width of the graphic frame in the specified units.
Position	Required	Inline Aboveline	The position of the frame.
YOffset	Implied		Offset from baseline (for inline max. line height).
XOffset	Implied		Offset from
Alignment	Implied	Left Right Center TowardsSpine AwayFromSpine TextAlignment	The inline frame alignment.
SpaceBefore	Implied		The space before an inline frame.
PreventManualPositioning	Implied	Yes No	Yes means inline frames are locked and can not be changed manually No means inline frames can be changed manually.
RelativeToSpine	Implied	Yes No	The inline frame can be positioned relative to layout properties.
AnchObjPtHor	Implied	Left Center Right	The inline frame(Obj) can be anchored relative to horizontal layout properties.
AnchObjPtVer	Implied	Top Center Bottom	The inline frame(Obj) can be anchored relative to vertical layout properties.
AnchPosPtHor	Implied	Left Center Right	The inline frame(Pos) can be relative to horizontal layout properties.
AnchPosPtVer	Implied	Top Center Bottom	The inline frame(Pos) can be relative to vertical layout properties.
XRelativeTo	Implied	AnchorMarker ColumnEdge TextFrame PageMargin PageEdge	The inline frame can be positioned relative to the X value.

Inline (Continued)

Attribute	Default	Value (default value in bold)	Description
YRelativeTo	Implied	Baseline LineCapHeight LineTopLeading ColumnEdge TextFrame PageMargin PageEdge	The inline frame can be positioned relative to the Y value.
BottomTopBoundries	Implied	Yes No	Yes means inline frames are placed within the flow boundaries. No means inline frames are placed within and without the flow boundaries.
Opacity	Implied	0-100	Integer The opacity in percentage of the graphic frame.
Transparency	Implied		The transparency of the graphic frame (as in InDesign).
CornerRadius	Implied		The corner effects setting in the specified units of the graphic frame.
CornerType	Implied		The corner effect setting of the graphic frame (as in InDesign).
Name	Implied		Frame label (not used for now).
Stroke	Implied		The stroke color in swatch or #rrggbb or cmyk. c=0;m=100;y=100;k=0;
StrokeThickness	Implied		The thickness of the stroke in points.
StrokeType	Implied	Solid ThickThick ThickThin ThickThinThick ThinThick ThinThickThin ThinThin Triple_Stroke Canned Dashed 3x2 Canned Dashed 4x4 Left Slant Hash Right Slant Hash Straight Hash Canned Dotted Wavy White Diamond Japanese Dots Dashed).	The type of stroke values.
Rotation	Implied		The rotation of the graphic frame rotated round the centre middle. In degrees.
Background	Implied		Background color in swatch or #rrggbb or cmyk c=0;m=100;y=100;k=0;
margin-left	Implied		Left margin in the specified units.
margin-top	Implied		Top margin in the specified units.
margin-right	Implied		Right margin in the specified units.
margin-bottom	Implied		Bottom margin in the specified units.
VerticalAlignment	Implied	Top Middle Bottom Justify	The vertical alignment of the content in the frame when "Type" text is used.
Id	Implied		The automatic generated identifier for this object.
Identifier	Implied		Can be used to specify an identifier for this object.
SitecoreID	Implied		Only used in combination with Sitecore. Identifies Sitecore items created from InDesign objects.
SitecoreFieldname	Implied		Only used in combination with Sitecore. Identifies Sitecore item fields used for creating InDesign objects.

Inline (Continued)

Attribute	Default	Value (default value in bold)	Description
Scaling	Implied	Fit Content to Frame Fit Frame to Content Center Content Fit Content Proportionally Fill Frame Proportionally Fit Content Proportionally and Center	Images can be scaled automatically.
HorizontalScale	Implied		Value - / +
VerticalScale	Implied		Value - / +
Skew	Implied		Value in degrees.
Center	Implied	True False	False do nothing True the image is placed as InDesign value "Center Content", attribute is used with scaling attributes (values).
FitFrame	Implied	True False	False do nothing True the frame is placed as InDesign value "Fit frame to Content", attribute is used with scaling attributes (values). When textual content, fit frame to content will only work when the number of columns is 1.
ObjectStyle	Implied		An InDesign Object Style can be used for formatting (effects). If the name of the Object Style used in the master is used as value of this attribute it will be applied.
FillTint	Implied		The percentage of the tint for the background color.
StrokeTint	Implied		The percentage of the tint for the stroke color.
WMode	Implied	0 1 2 3 4 5 6 7 8	Wrap mode 0 no text wrap 1 jump object 2 jump to next column 3 wrap around bounding box 4 Invalid, unimplemented 5 Invalid, unimplemented 6 wrap around object shape 7 Invalid, unimplemented 8 Invalid, unimplemented
WOffset	Implied	top;left;bottom;right;single	Distance of wrap offset Ex: 1;2;1;2;0; Whether the item only supports one value for all sides (that is topMargin is the only valid margin) values 1/0.
WInvert	Implied	0 1	Invert text wrap.
WSide	Implied	0 1 2 3 4 5	Wrap side 0 both left & right sides 1 Left side 2 Right side 3 Side Towards Spine 4 Side Away from Spine 5 Largest Area)
WIgnore	Implied	1 0	Ignore textwrap (only for text frames) 1 Ignore textwrap
LCap	Implied	0 1 2	Line cap 0 But cap 1 Round cap 2 Projecting cap
JType	Implied	0 1 2	Join type 0 Miter join 1 Round join 2 Bevel join
MLim	Implied		Miter limit
SAlign	Implied	0 1 2	Stroke alignment 0 Align stroke to center 1 Align stroke to inside 2 Align stroke to outside

Inline (Continued)

Attribute	Default	Value (default value in bold)	Description
LEnd	Implied	Simple Bar SquareSolid Square CircleSolid Circle Curved Barbed TriangleWide Triangle SimpleWide	(Line end) and LStart (line start)
BalCols	Implied	True/False	Balance columns

Chapter 8

Flow Elements

Although most InDesign productions are page-oriented, the Engine also allows to produce more data driven productions. In this case pages are added if more space is needed to flow the content.

This chapter contains the following sections:

- Flows Element
- Flow Element
- Footnote Element

8.1 Flows Element

The Flow element has the following child elements:

- Flow Element
- Footnote Element

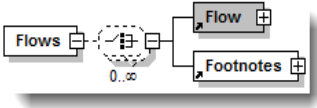

8.2 Flow Element

The Flow element has the child ParagraphStyle Element.

Flow

Attribute	Default	Value(s)	Description
MasterPrefix	Required		For InDesign for example "A", "B" and so on.
MasterBase	Required		For InDesign for example "Master".

When using a Flow type production, pages are automatically added when necessary. The content is placed automatically using a globally defined text frame. These text frames are fetched from the master page referred to by using the MasterPrefix and MasterBase attributes of the Flow element. Make sure your master pages contain these text frames and are placed in a layer called "flow". See the following example:

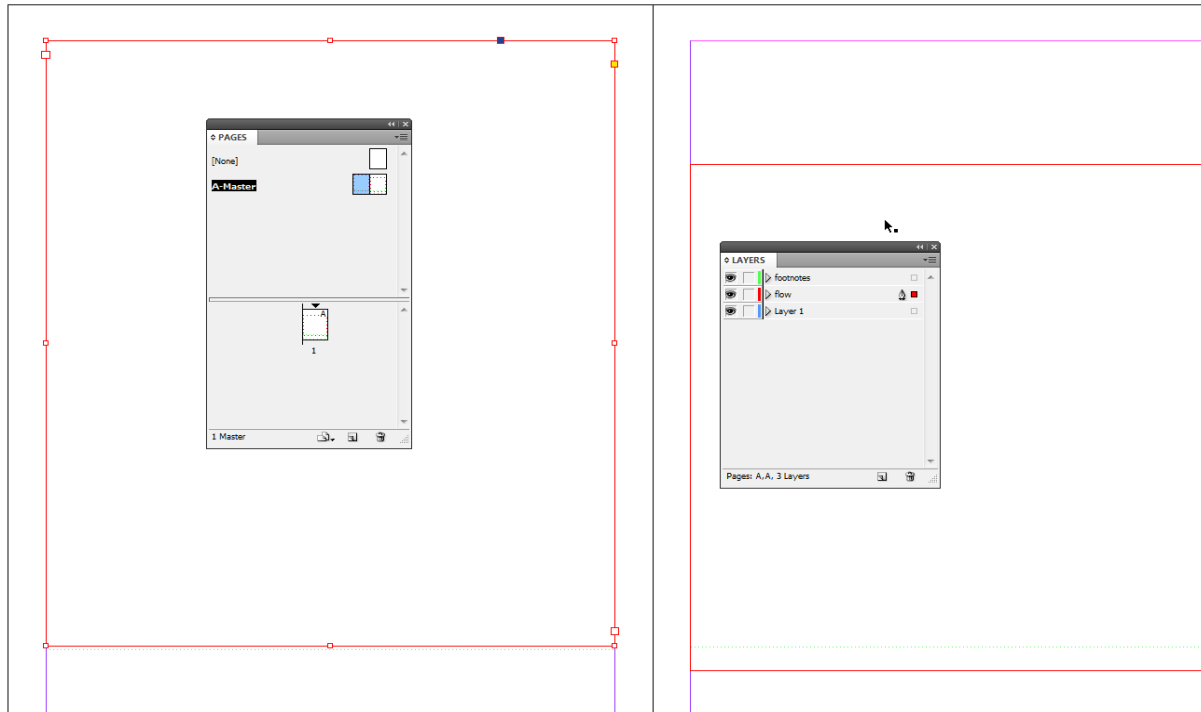

The very basic structure of a flow type production looks like:

```

1  <?xml version="1.0" encoding="UTF-8" standalone="yes"?>
2  <Project>
3  <Books>
4  <Book BookFilename="" ExportPDF="False" PrintBook="False">
5  <Documents>
6  <Document Type="Dynamic" MasterFilename="C:\temp\simpleDocMaster.indd" DocFilename="C:\temp\simpleDoc.indd">
7  <Pages>
8  <Flow MasterPrefix="A" MasterBase="Master">
9  <ParagraphStyle Style="BodyText">Some content</ParagraphStyle>
10 </Flow>
11 </Pages>
12 </Document>
13 </Documents>
14 </Book>
15 </Books>
16 </Project>
17

```

Or when combined with a page type production:

```
1 <?xml version="1.0" encoding="UTF-8" standalone="yes"?>
2 <Project>
3 <Books>
4 <Book BookFilename="" ExportPDF="False" PrintBook="False">
5 <Documents>
6 <Document Type="Dynamic" MasterFilename="C:\temp\simpleDocMaster.indd" DocFilename="C:\temp\simpleDoc.indd">
7 <Pages>
8 <Page MasterPrefix="A" MasterBase="Master" Number="1">
9 <Rectangle X="50" Y="50" Width="100" Height="100" Z-Index="1"/>
10 </Page>
11 <Page MasterPrefix="A" MasterBase="Master" Number="">
12 <Rectangle X="50" Y="50" Width="100" Height="100" Z-Index="1"/>
13 </Page>
14 <Flow MasterPrefix="A" MasterBase="Master">
15 <ParagraphStyle Style="BodyText">Some content</ParagraphStyle>
16 </Flow>
17 </Pages>
18 </Document>
19 </Documents>
20 </Book>
21 </Books>
```

8.3 Footnote Element

The Footnote element has the following child element:

- ParagraphStyle Element

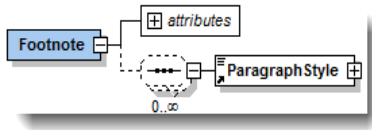

Footnote

Attribute	Default	Value(s)	Description
Name	Required		The name of the footnote used for matching, there must be an <InsertVar Name=""/> with the same name.
AutoNumber	Required	True False	True the footnote will be numbered automatically according to selected value of the attribute type.
Type	Required	Numbers Alphabetical	The selected type of numbering.
Prefix	Required		The characters set before the Number or Letter (alphabetical) for example Nr_ or Fn_
Suffix	Required		The characters set after the Number or Letter (alphabetical) for example 1_Fn
Style	Required	NoCharacterStyle	The style (character style) used for formatting the AutoNumber. The paragraph style set for the Footnote (and AutoNumber) is the style of the first paragraph style of Footnote.

The footnotes are defined in a general section (child of flows). Each footnote can be referenced in the content by inserting a variable (InsertVar element) that has a name that corresponds with the name of the footnote. The Engine will collect and publish all the referenced footnotes on the specific page.

The footnotes will be published inside a text frame that is globally defined on the master pages that are referenced for the flow. Make sure the master page has a text frame on a layer called “flow” as you can see in the following screenshot.

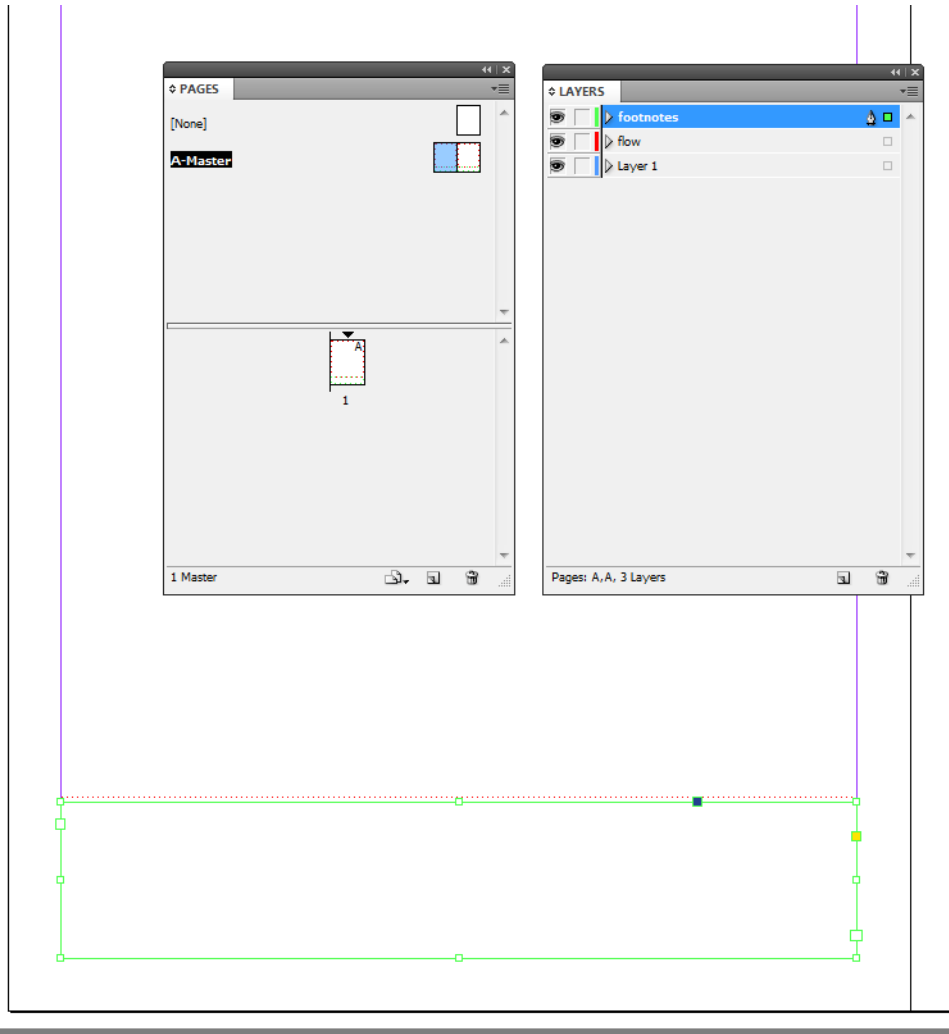

The basic XML structure looks like:

```

<?xml version="1.0" encoding="UTF-8" standalone="yes"?>
<object Units="points" CloseProject="True">
  <Books>
    <Book BookFilename="" ExportPDF="False" PrintBook="False">
      <Documents>
        <Document Type="Dynamic" MasterFilename="C:\temp\tests\footnotemaster.indd" DocFilename="C:\temp\tests\output_test.indd" PageWidth="612.0000000000000000" PageHeight="792.0000000000000000">
          <Flows>
            <Footnotes>
              <Footnote Name="FN_1" Autonumber="False" Type="Numbers" Style="Super" Prefix="Nr." Suffix="...">
                <ParagraphStyle Style="NormalParagraphStyle"><[CDATA[footnote 1]]></ParagraphStyle>
              </Footnote>
              <Footnote Name="FN_2" Autonumber="True" Type="Numbers" Style="Super" Prefix="Nr." Suffix="...">
                <ParagraphStyle Style="NormalParagraphStyle"><[CDATA[footnote 2]]></ParagraphStyle>
              </Footnote>
              <Footnote Name="FN_3" Autonumber="True" Type="Alphabetical" Style="Super" Prefix="Nr." Suffix="...">
                <ParagraphStyle Style="NormalParagraphStyle"><[CDATA[footnote 3]]></ParagraphStyle>
              </Footnote>
            </Footnotes>
            <Flow MasterPrefix="A" MasterBase="Master">
              <ParagraphStyle Style="NormalParagraphStyle"><[CDATA[Some content]]><InsertVar Name="FN_1" Value=""><[CDATA[]]></ParagraphStyle>
              <ParagraphStyle Style="NormalParagraphStyle"><[CDATA[More content]]><CharacterStyle Style="Super"><InsertVar Name="FN_2" Value=""></CharacterStyle></ParagraphStyle>
              <ParagraphStyle Style="NormalParagraphStyle"><[CDATA[And even more content]]><InsertVar Name="FN_3" Value=""></ParagraphStyle>
            </Flow>
          </Flows>
        </Document>
      </Documents>
    </Book>
  </Books>
</object>

```

This will create the following document:

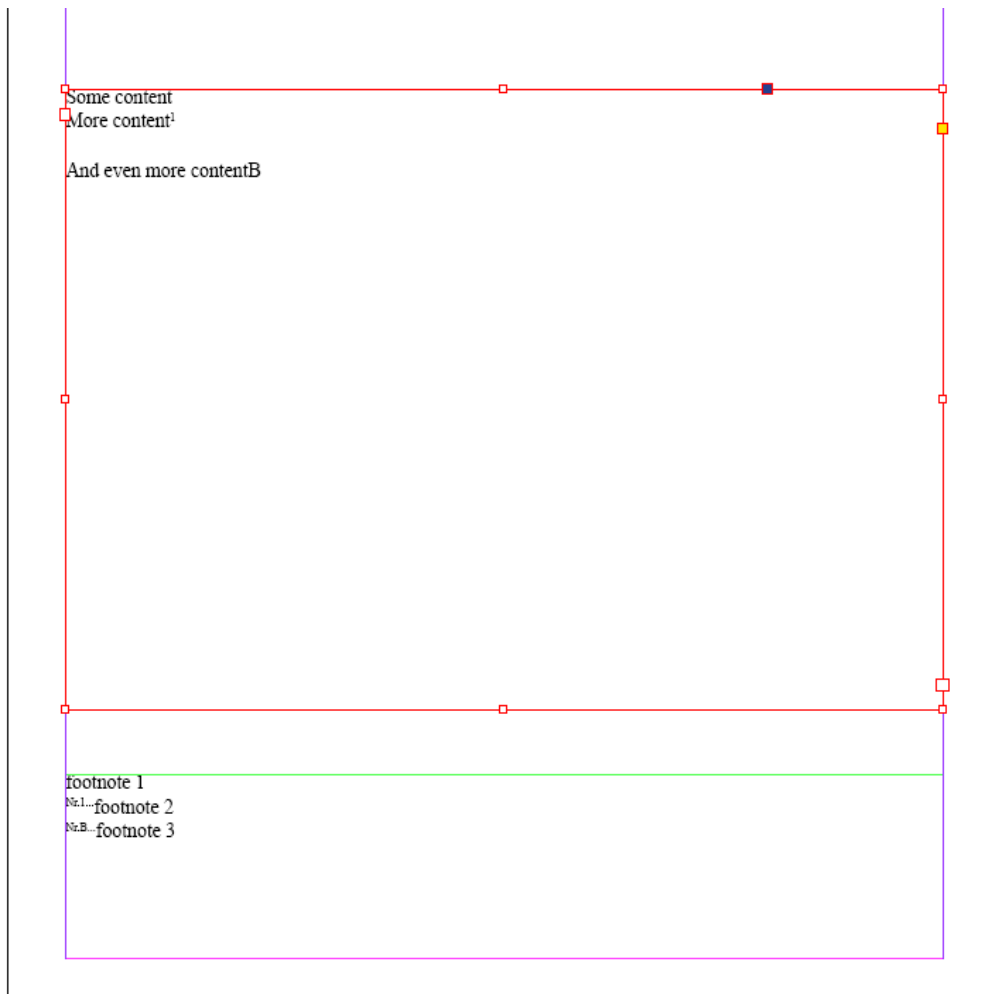

Chapter 9

Style Elements

The style settings can be stored inside the master document. They can also be defined in XML. The XML values overrule the settings in the master. These style settings are documented in this chapter.

This chapter contains the following sections:

- Preferences Element
- Colors Element
- Swatch Element
- Layer Element
- Styles Element
- Style Element

9.1 Preferences Element

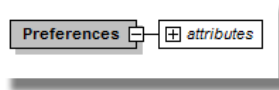

Preferences

Attribute	Default	Value(s)	Description
SuperScriptPos	Implied		In points
SuperScriptSize	Implied		In points
SubScriptPos	Implied		In points
SubScriptSize	Implied		In points

9.2 Colors Element

The colors element has the following child elements:

- Swatch Element

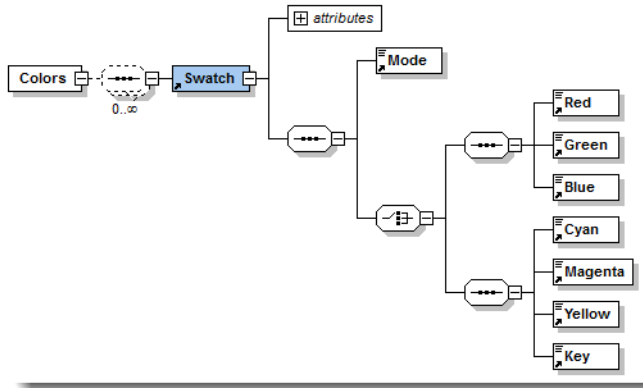

9.3 Swatch Element

The Swatch element has the following child elements:

- **Mode** - Color mode (RGB/CMYK)
- **Red** - Integer (0-255)
- **Green** - Integer (0-255)
- **Blue** - Integer (0-255)
- **Cyan** - Integer (0-100)
- **Magenta** - Integer (0-100)
- **Yellow** - Integer (0-100)
- **Key** - Integer (0-100)

Swatch

Attribute	Default	Value(s)	Description
Name	Required		The name of the swatch.

9.4 Layer Element

The Layer element holds the following child elements:

- **Name:** The name of the layer. If it does not exist, it will be created.
- **Z-Index:** The z-index of this layer. If unknown, just use any value like 0 or 1.
- **Visible:** The layer is visible or not.
- **Locked:** The layer is locked or not.
- **Printable:** The layer is printable or not.

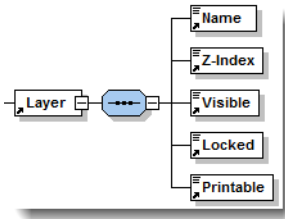

9.5 Styles Element

The Styles element has the following child elements:

- ParagraphStyle Element
- CharacterStyle Element
- TableStyle Element
- CellStyle Element

9.6 Style Element

The style element has the following attribute:

- **Stylename** - required by default.

The table below lists all the child elements of the Style element.

Style

Element (child element)	Attribute(s)	Default	Description
BalanceLines			Balance ragged lines.
BaselineShift			The BaselineShift.
BorderColor			Border color for table or cell styles.
BorderGapColor			Border gap color for table or cell styles.
BorderGapOverprint			Border gap overprint for table or cell styles.
BorderGapTint			Border gap tint for table or cell styles.
BorderOverprint			Border overprint for table or cell styles.
BorderTint			Border tint for table or cell styles.
BorderType			Border type for table or cell styles.
BorderWeight			Border weight for table or cell styles.
Bullets	BulletChar TextAfter CharStyle Number ContinueFromPrevious StartAt		The bullets for paragraph or character styles.
Case			The case for paragraph or character styles.
CharacterColor	FillOverprint FillTint StrokeColor StrokeOverprint StrokeTint StrokeWeight	Required Required Required Required Required	Used for the Character Color tab.
Clipping			Clipping for table or cell styles.
ColumnStrokes	FirstCount FirstWeight FirstType FirstColor FirstTint FirstOverprint FirstGapColor FirstGapTint FirstGapOverprint NextCount NextWeight NextType NextColor NextTint NextOverprint NextGapColor NextGapTint NextGapOverprint SkipFirst SkipLast		The ColumnStrokes tab of the table styles.
DiagnolColor			Diagnol color type for table or cell styles.
DiagnolGapColor			Diagnol gap color for table or cell styles.
DiagnolGapOverprint			Diagnol gap overprint for table or cell styles.
DiagnolGapTint			Diagnol gap tint for table or cell styles.

Style

Element (child element)	Attribute(s)	Default	Description
DiagnolLine			Diagnol line for table or cell styles.
DiagnolOverprint			Diagnol overprint for table or cell styles.
DiagnolsOnTop			Diagnols on top for table or cell styles.
DiagnolStrokeType			Diagnol stroke type for table or cell styles.
DiagnolTint			Diagnol tint for table or cell styles.
DiagnolWeight			Diagnol weight for table or cell styles.
FillColor			Fill color for table or cell styles.
FillOverprint			Fill overprint for table or cell styles.
Fills	Pattern FirstCount FirstColor FirstTint FirstOverprint NextCount NextColor NextTint NextOverprint SkipFirst SkipLast	Required Required Required Required Required Required Required Required Required Required Required	The Fills tab of the table styles.
FillTint			Fill tint for table or cell styles.
FirstBaselineMin			First baseline minimum for table or cell styles.
FirstBaselineOffset			First baseline offset for table or cell styles.
FirstLineIndent			The indent for the first line.
FontColor			The font color for paragraph or character styles. The hex. Value of the RGB color values (for example #29292D) or the name of a swatch.
FontFamily			The name of the font family for paragraph or character styles.
FontSize			The font size (points) for paragraph or character styles.
FontStyle			The font style for paragraph or character styles.
HorizontalAlignment			The horizontal alignment for paragraph or character styles.
HorizontalScale			The HorizontalScale (Advanced Character Formats).
Hyphenation	Capitalized Ladder LastWord Limit Zone CrossColumn AfterFirst BeforeLast ShortestWord Mode	Required Required Required Required Required Required Required Required Required Required	Used for the Hyphenation tab.
InsetBottom			Inset bottom for table or cell styles.
InsetLeft			Inset left for table or cell styles.
InsetRight			Inset right for table or cell styles.
InsetTop			Inset top for table or cell styles.

Style

Element (child element)	Attribute(s)	Default	Description
Justification	WordSpaceMin WordSpaceMax WordSpaceDes GlyphScaleMin GlyphScaleMax GlyphScaleDes LetterSpaceMin LetterSpaceMax LetterSpaceDes AutoLeading SingleWordJustification	Required Required Required Required Required Required Required Required Required Required	Used for the justification tab.
Kerning			The kerning (Basic Character Formats).
Language	See Language Values		The language used for determining hyphens.
LastLineIndent			The indent for the last line.
Leader	CharValue	Required	
LeftIndent			The left indent for paragraph or character styles.
LetterSpacing			The letter spacing for paragraph or character styles.
Ligatures			The ligatures (Basic Character Formats).
LineHeight			The line height for paragraph or character styles.
NoBreak			The No Break (Basic Character Formats).
Position			The position for paragraph or character style
RightIndent			The right indent for paragraph or character styles.
RowStrokes	FirstCount FirstWeight FirstType FirstColor FirstTint FirstOverprint FirstGapColor FirstGapTint FirstGapOverprint NextCount NextWeight NextType NextColor NextTint NextOverprint NextGapColor NextGapTint NextGapOverprint SkipFirst SkipLast	Required Required Required Required Required Required Required Required Required Required Required Required Required Required Required Required Required Required Required	The RowStrokes tab of the table styles.
RuleAbove	RuleOn StrokeWeight StrokeType StrokeColor StrokeTint StrokeOverprint GapColor GapTint GapOverprint Width Offset LeftIndent RightIndent KeepInFrame	Required Required Required Required Required Required Required Required Required Required Required Required Required	The ParagraphRules tab of the paragraph styles.

Style

Element (child element)	Attribute(s)	Default	Description
RuleBelow	RuleOn StrokeWeight StrokeType StrokeColor StrokeTint StrokeOverprint GapColor GapTint GapOverprint Width Offset LeftIndent RightIndent	Required Required Required Required Required Required Required Required Required Required Required Required	The ParagraphRules tab of the paragraph styles.
SkewAngle			The skew angle for the characters.
SpaceAfter			Space after table for table styles.
SpaceBefore			Space before table for table styles.
Strikethrough	Weight Type Offset Color Tint StrokeOverprint GapColor GapTint GapOverprint	Required Required Required Required Required Required Required Required Required	Strike through yes or no for paragraph or character styles.
StrokeColor	Left Top Right Bottom	Required Required Required Required	Stroke Color for table or cell styles. When value is inserted for element this will overrule the values set with the attributes.
StrokeGapColor	Left Top Right Bottom	Required Required Required Required	StrokeGapColor for table or cell styles. When value is inserted for element this will overrule the values set with the attributes.
StrokeGapOverprint	Left Top Right Bottom	Required Required Required Required	StrokeGapOverprint for table or cell styles. When value is inserted for element this will overrule the values set with the attributes.
StrokeGapTint	Left Top Right Bottom	Required Required Required Required	StrokeGapTint for table or cell styles. When value is inserted for element this will overrule the values set with the attributes.
StrokeOverprint	Left Top Right Bottom	Required Required Required Required	StrokeOverprint for table or cell styles. When value is inserted for element this will overrule the values set with the attributes.
StrokeTint	Left Top Right Bottom	Required Required Required Required	StrokeTint for table or cell styles. When value is inserted for element this will overrule the values set with the attributes.
StrokeType	Left Top Right Bottom	Required Required Required Required	Stroke type for table or cell styles. When value is inserted for element this will overrule the values set with the attributes.
StrokeWeight	Left Top Right Bottom	Required Required Required Required	Stroke weight for table or cell styles. When value is inserted for element this will overrule the values set with the attributes.
Tab (Leader)	LeaderCount Alignment AlignToChar Position	Required Required Required Required	
Tabs (Tab)			For the Tabs tab.
TextRotation			Text rotation for table or cell styles.

Style

Element (child element)	Attribute(s)	Default	Description
Tracking			The tracking (Basic Character Formats).
Underline	Weight Type Offset Color Tint StrokeOverprint GapColor GapTint GapOverprint	Required Required Required Required Required Required Required Required	Underline yes or no for paragraph or character styles.
VerticalJustification			Vertical justification for table or cell styles.
VerticalScale			The VerticalScale (Advanced Character Formats).
VJSpacingLimit			Vertical justification spacing limit for table or cell styles.

Language Values

Language in InDesign	Internal value to use in XML
English UK:	English: UK
Bulgarian:	Bulgarian
Catalan:	Catalan
Croatian:	Croatian
Czech:	Czech
Danish:	Danish
Dutch: 2005 Reform	nl_NL_2005
Dutch: Old Rules:	Dutch
English Canadian:	English: Canadian
English USA	English: USA
English: USA Legal	English: USA Legal
English: USA Medical	English: USA Medical
Estonian	Estonian
Finnish	Finnish
French	French
French: Canadian	French: Canadian
German: Reformed	German: Reformed
German 2006 Reform	de_DE_2006
German Old Rules	German: Traditional
German: Swiss	German: Swiss
German: Swiss 2006 Reform	de_CH_2006
Greek	Greek
Hungarian	Hungarian
Italian	Italian
Latvian	Latvian
Lithuanian	Lithuanian
Norwegian: Bokmal	Norwegian: Bokmal

Language in InDesign	Internal value to use in XML
Norwegian: Nynorsk	Norwegian: Nynorsk
Polish	Polish
Portuguese: Orthographic	Orthographic Agreement
Portuguese	Portuguese
Portuguese: Brazilian	Portuguese: Brazilian
Romanian	Romanian
Russian	Russian
Slovak	Slovak
Slovenian	Slovenian
Spanish	Spanish: Castilian
Swedish	Swedish
Turkish	Turkish
Ukrainian	Ukrainian

Chapter 10

Special Elements

This chapter describes special elements.

10.1 Variable Element

The Variable element has the following child elements:

- Find
- Replace

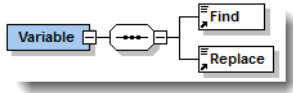

The variable element allows you to set the variable contents (variable of the type “Custom Text”). Be aware that it does not create a variable if it does not exist in the master document, it only sets the content.

To create a variable in the master document:

1. Select **Type, Text Variables, Define** from the InDesign main menu:

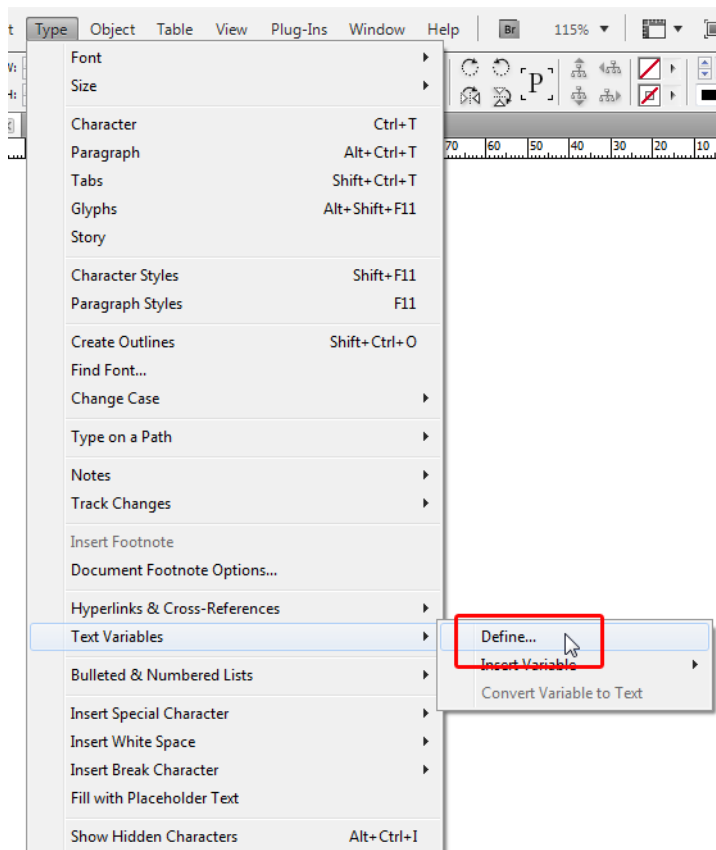

The **Text Variables** dialog is displayed:

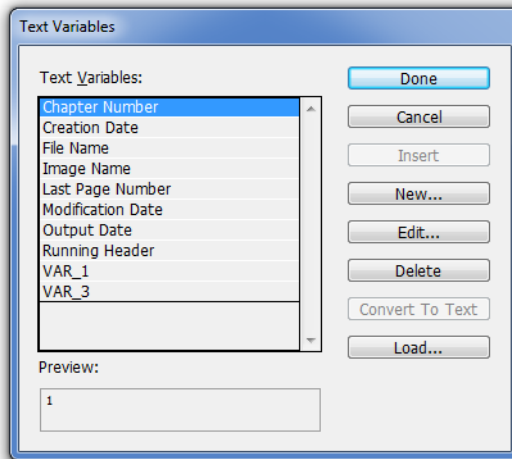

2. Click **New**. The “New Text Variable” is displayed:

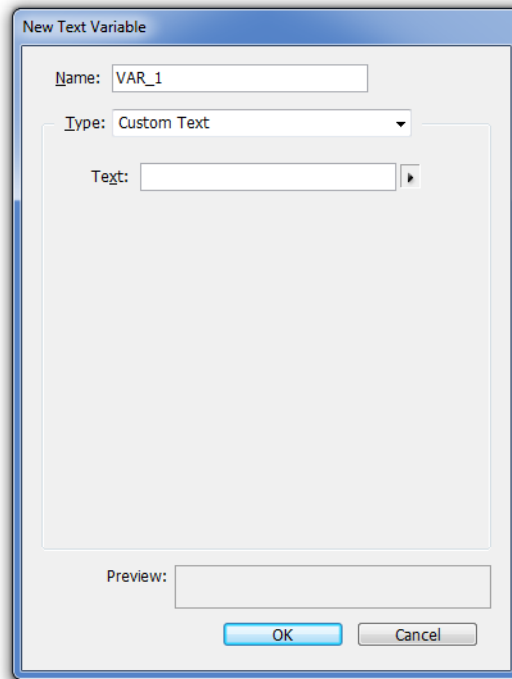

3. Select the **Custom Text** as a type and fill in the **Name** field with the value that corresponds to the name value of your **Find** element in the XML.

```
<Variables>
  <Variable>
    <Find>VAR_1</Find>
    <Replace>this is VAR_1</Replace>
  </Variable>
</Variables>
```

A variable can be inserted in the content by using the **InsertVar** element. To illustrate how both work together:

```

1 <?xml version="1.0" encoding="UTF-8" standalone="yes"?>
2 <Project>
3 <Books>
4 <Book BookFilename="" ExportPDF="False" PrintBook="False">
5 <Documents>
6 <Document Type="Dynamic" MasterFilename="c:\temp\tests\VARSmaster.indd" DocFilename="c:\temp\tests\VARs_test.indd" PageWidth
7 <Variables>
8 <Variable>
9 <Find>VAR_1</Find>
10 <Replace>this is VAR_1</Replace>
11 </Variable>
12 </Variables>
13 <Pages>
14 <Page MasterPrefix="A" MasterBase="Master" Number="3">
15 <TextFrame Width="200" Height="200" X="120" Y="120" Z-Index="0">
16 <ParagraphStyle Style="P_ProductGroup">Some content</ParagraphStyle>
17 <ParagraphStyle Style="Body">create var in content: <InsertVar Name="VAR_3" Value="this is VAR_3"/></ParagraphStyle>
18 <ParagraphStyle Style="Body">use var 1: <InsertVar Name="VAR_1" Value=""/></ParagraphStyle>
19 <ParagraphStyle Style="Body">and var 3 again: <InsertVar Name="VAR_3" Value=""/></ParagraphStyle>
20 <ParagraphStyle Style="Body">creation date var: <InsertVar Name="VAR_X" Value=""/></ParagraphStyle>
21 <ParagraphStyle Style="Body">other var: <InsertVar Name="VAR_X1" Value="test"/></ParagraphStyle>
22 </TextFrame>
23 </Page>
24 </Pages>
25 </Document>
26 </Documents>
27 </Book>
28 </Books>
29 </Project>
30

```

In this sample XML we set the value of the VAR_1 variable to “this is VAR_1. In the content we use the “InsertVar” element to create a new variable called “VAR_3”. We then insert the variable “VAR_1”. Then we insert the “VAR_3”. Then we insert the variable “VAR_X”, which corresponds to a variable of the type “Creation date” in the master. And finally we create a new variable called “VAR_X1” and set the value of that variable to “test”.

This would result in:

